

embraco
Nidec

COMPRESSOR INSTALLATION INSTRUCTIONS



**FOR EMBRACO EUROPEAN
ON-OFF COMPRESSORS**



SCOPE OF THE COMPRESSORS INSTALLATION INSTRUCTIONS

This Installation Instructions applies to the Embraco on-off compressors produced in Europe (the country of origin is indicated on the compressor label).

It is addressed to professional users, refrigeration system manufacturers/installers and maintenance technicians and intends to provide instructions/recommendations on the proper use of Embraco compressors regarding reliability, performance and safety aspects.

The information of this Installation Instructions is limited to the Embraco european on-off compressors and to their installation/operation/service. They are not to be considered comprehensive or as a set of information for training for technicians that need to be qualified by appropriated training nor to replace the instruction manual of the final equipments provided by the manufacturers.

All the operation on systems, their production, installation use, repairing and disposal must be carried out according to all the applicable International and National regulations and standards.

DISCLAIMER

All product, product specifications and data are subject to change without notice; thus customer should always verify its latest updates on Embraco website (www.embraco.com), catalogues before relying on them.

The information provided herein is correct to the best of Embraco's knowledge of typical requirements that are often requested to Embraco's products. It is the customer's responsibility, relying solely on its own testing and engineering work, to validate that a particular product with the properties described in Embraco's product specification is suitable for use in a particular application. Embraco makes no representation concerning the suitability of its products for incorporation into or use with customer's applications.

Parameters provided in datasheets and / or specifications may vary in different applications and performance over time. Therefore Embraco's statements related to all operating parameters, including typical parameters, cannot be intended to replace the customer's validation for each application by the customer's technical experts. Product specifications do not expand or otherwise modify Embraco's terms and conditions of purchase, including but not limited to the warranty expressed therein.

Embraco rejects any liability for damages and injures caused by its products and/or the applications they are embedded into being installed or repaired by untrained personnel and/or in discordance with these safety instructions.

GENERAL INDEX

1	SAFETY	p. 11
1.1	Safety notice	p. 11
1.2	Safety advice	p. 11
2	COMPRESSOR APPLICABLE STANDARDS AND DIRECTIVES	p. 12
2.1	PED Category II	p. 12
2.1.1	Compressor label for PED II	p. 12
	<i>Figure 2.1.1 Compressor label for PED II</i>	<i>p. 13</i>
2.1.2	Specification	p. 13
3	EMBRACO COMPRESSOR RELEVANT DOCUMENTS	p. 13
4	COMPRESSOR RANGE	p. 13
4.1	Application description	p. 13
	<i>Table 4.1 Applications</i>	<i>p. 14</i>
4.2	Starting torque classification	p. 14
	<i>Table 4.2 Electrical motor starting torque classification</i>	<i>p. 14</i>
4.3	Electrical motor types	p. 15
	<i>Table 4.3 Electrical motor types</i>	<i>p. 15</i>
4.4	Electrical motor voltages and frequencies	p. 16
	<i>Table 4.4 Compressor voltages & frequencies, operating voltage range and minimum starting voltage</i>	<i>p. 16</i>
4.5	Electrical components types	p. 17
	<i>Table 4.5 Electrical components types</i>	<i>p. 17</i>
4.6	Compressor cooling types	p. 18
	<i>Table 4.6 Cooling types</i>	<i>p. 18</i>
5	COMPRESSOR NAMEPLATES, MODEL, BILL OF MATERIAL CODE, TEST CONDITIONS	p. 19
5.1	Compressor label	p. 19
	<i>Figure 5.1 Compressor label</i>	<i>p. 19</i>
5.2	Compressor model code	p. 20
	<i>Figure 5.2.1 EM / NE / NT / NJ model code</i>	<i>p. 20</i>
	<i>Figure 5.2.2 EM model code</i>	<i>p. 20</i>
5.3	<i>Figure 5.3</i> Compressor Bill of material code	p. 21
5.4	Manufacturing date code	p. 21
	<i>Figure 5.4 Date code</i>	<i>p. 21</i>
5.5	Compressor test condition	p. 22
	<i>Table 5.5 Test condition</i>	<i>p. 22</i>
6	WIRING DIAGRAMS	p. 22
6.1	Electrical connections	p. 22
	<i>Figure 6.1.a Wiring diagrams key</i>	<i>p. 23</i>
	<i>Figure 6.1.b Wiring diagrams</i>	<i>p. 24</i>

6.1.1	Notes on electrical components assembly	p.	31
	<i>Figure 6.1.1 Electrical box mounting position.....</i>	<i>p.</i>	<i>31</i>
6.2	Compressor pin position	p.	32
	<i>Figure 6.2.1 EM / NE / NT / NJ models pin position.....</i>	<i>p.</i>	<i>32</i>
6.3	Screw clamping torque of supplied components.....	p.	32
6.4	Screw final tightening.....	p.	32
6.5	Quick connection (faston).....	p.	32
7	COMPRESSOR SUPPLY CONDITIONS.....	p.	33
7.1	Compressor performance	p.	33
7.2	Compressor external views.....	p.	33
7.3	Electrical insulation	p.	33
7.4	Compressor approvals by Safety Institutes	p.	33
7.5	"IP" degree of protection	p.	34
	<i>Table 7.5 IP Degree.....</i>	<i>p.</i>	<i>34</i>
	<i>Figure 7.5.a NT with vertical terminal fence</i>	<i>p.</i>	<i>34</i>
	<i>Figure 7.5.b NT with horizontal terminal fence.....</i>	<i>p.</i>	<i>34</i>
	<i>Figure 7.5.c CSR box – IP34</i>	<i>p.</i>	<i>35</i>
7.6	Compressor shell hydrostatic strength	p.	35
7.7	Dehydration	p.	35
	<i>Table 7.7 Maximum level of residual humidity (H2O mg).....</i>	<i>p.</i>	<i>35</i>
7.8	Painting	p.	35
7.9	Compressor pressurization	p.	36
7.10	Oil charge.....	p.	36
	<i>Table 7.10 Lubricant oils approved for compressors.....</i>	<i>p.</i>	<i>36</i>
7.11	Minimum quantity of lubricant inside the compressor	p.	37
	<i>Table 7.11 Minimum quantity of lubricant.....</i>	<i>p.</i>	<i>37</i>
7.12	Special versions	p.	37
	<i>Table 7.12 Special external version examples.....</i>	<i>p.</i>	<i>37</i>
8	COMPRESSOR PACKAGING.....	p.	38
8.1	Multiple packaging	p.	38
	<i>Table 8.1.1 Pallet packages composition.....</i>	<i>p.</i>	<i>38</i>
	<i>Figures 8.1.1. a – f Compressor package type pictures.....</i>	<i>p.</i>	<i>38</i>
	<i>Table 8.1.2 Characteristics of multiple wooden packaging</i>	<i>p.</i>	<i>39</i>
8.2	Single packaging.....	p.	39
	<i>Figure 8.2.1 Carton box for single package</i>	<i>p.</i>	<i>39</i>
	<i>Figure 8.2.2 Single compressor palet package.....</i>	<i>p.</i>	<i>39</i>
	<i>Table 8.2 Characteristics of complete single package</i>	<i>p.</i>	<i>40</i>
8.3	Package for electrical components and accessories.....	p.	40
8.4	Compressor identification marks	p.	41
	<i>Figure 8.4.1 Compressor identification label for multiple packaging.....</i>	<i>p.</i>	<i>41</i>
	<i>Figure 8.4.2 Compressor identification label for single packaging.....</i>	<i>p.</i>	<i>41</i>

9	HANDLING, TRANSPORTING AND STORING	p. 42
9.1	Handling.....	p. 42
9.2	Transportation.....	p. 42
9.2.1	Shipment by container	p. 42
	<i>Table 9.2.1 Load characteristics for 20ft container</i>	<i>p. 43</i>
9.2.2	Shipments by truck.....	p. 44
	<i>Table 9.2.2 Characteristics of load by truck.....</i>	<i>p. 44</i>
9.3	Acceptable compressor positions during transportation	p. 44
	<i>Table 9.3 Acceptable compressor position during transportation of finished products .p.</i>	<i>45</i>
9.4	Acceleration during transport and handling	p. 46
9.5	Compressor storage	p. 46
	<i>Table 9.5.1 Compressor multiple package storage - maximum height</i>	<i>p. 46</i>
	<i>Table 9.5.2 Compressor single package storage - maximum height</i>	<i>p. 47</i>
9.6	Storage conditions.....	p. 47
10	INFORMATION ABOUT CORRECT COMPRESSOR INSTALLATION	p. 48
10.1	Compressor selection.....	p. 48
10.1.1	Characteristics of the hermetic compressor.....	p. 48
10.1.2	Selecting the proper compressor	p. 48
10.1.3	Recommended guideline for the compressor selection.....	p. 49
10.1.3.1	Minimum / maximum evaporating temperature	p. 49
10.1.3.2	Appropriate cooling capacity.....	p. 49
10.1.3.3	Refrigerant type	p. 49
10.1.3.4	Electric motor starting torque.....	p. 49
10.1.3.5	Supply voltages and frequencies	p. 50
10.1.3.6	Ambient temperature.....	p. 50
10.1.3.7	Compressor cooling type	p. 51
	<i>Table 10.1.3.7 Fan cooler characteristics</i>	<i>p. 51</i>
	<i>Figure 10.1.3.7 Fan motor position</i>	<i>p. 52</i>
10.1.4	Noise and vibrations.....	p. 52
10.1.5	Maximum continuous current.....	p. 53
10.1.6	Overload protector.....	p. 53
10.1.7	Electrical supply line and cabinet supply cable	p. 54
10.2	Compressor unpacking.....	p. 54
10.3	System components.....	p. 55
10.3.1	Humidity and contaminants.....	p. 55
	<i>Table 10.3.1a Soluble, insoluble and solid residuals limits</i>	<i>p. 55</i>
	<i>Table 10.3.1b Humidity limits.....</i>	<i>p. 55</i>
10.3.2	Piping basic principles.....	p. 56
10.3.2a	Evaporator and condenser.....	p. 56
10.3.2b	Liquid lines - valid also for close coupled remote system.....	p. 56
10.3.2c	Suction lines - valid also for close coupled remote system.....	p. 57

10.3.3	Expansion devices.....	p.	58
10.3.3a	Capillary	p.	58
10.3.3b	Thermostatic expansion valve (TXV).....	p.	58
10.3.4	Use of liquid separator and crankcase heater.....	p.	58
10.3.5	Leak control.....	p.	59
10.3.6	High pressure control	p.	59
10.3.7	Compressors with internal pressure relief valve (IPR).....	p.	59
10.3.8	Embraco compressors with oil equalization tube for Gemini (Twin).p.		60
	<i>Figure 10.3.8.1 Gemini compressor with connection port.....</i>	<i>p.</i>	<i>61</i>
	<i>Figure 10.3.8.2 Compressor mounting and oil level indication</i>	<i>p.</i>	<i>62</i>
10.4	Liquid line filter dryer	p.	63
	<i>Table 10.4a Suggested filter dryer molecular sieves: 3 or 4 Angstrom.....</i>	<i>p.</i>	<i>63</i>
	<i>Table 10.4b Inconvenient caused by humidity in the system.....</i>	<i>p.</i>	<i>64</i>
10.5	Brazing process	p.	64
10.6	Refrigerant use guide	p.	65
10.6.1	Guide line for use of HFCs R134a, R404A and R407C	p.	65
10.6.1.1	HFCs R134a, R404A, R407C general information	p.	65
	<i>Table 10.6.1.1 R134a, R404A and R407C characteristics.....</i>	<i>p.</i>	<i>65</i>
10.6.1.2	System components compatibility	p.	66
10.6.1.3	System evacuation	p.	66
10.6.1.4	Refrigerant charge	p.	67
10.6.1.5	Embraco compressor max refrigerant charge	p.	68
	<i>Table 10.6.1.5 Max refrigerant charge admitted in the Embraco compressors</i>	<i>p.</i>	<i>68</i>
10.6.1.6	Alternative refrigerants	p.	68
	<i>Table 10.6.16 R452A, R449A, R448A, R513A and R450A characteristics</i>	<i>p.</i>	<i>68</i>
10.6.1.6a	R404A.....	p.	69
10.6.1.6b	R134a.....	p.	69
10.6.2	Guide for the use of HCs refrigerants R600a and R290.....	p.	69
10.6.2.1	HCs R600a and R290 general information.....	p.	70
	<i>Table 10.6.2.1 R600a and R290 characteristics.....</i>	<i>p.</i>	<i>70</i>
10.6.2.2	R600a and R290 purity	p.	71
10.6.2.3	Embraco R600a and R290 identification and warning symbols	p.	71
	<i>Figure 10.6.2.3 Warning symbol.....</i>	<i>p.</i>	<i>71</i>
10.6.2.4	Safety warnings.....	p.	71
10.6.2.5	System components compatibility	p.	72
10.6.2.6	Expansion devices.....	p.	72
10.6.2.7	Liquid and suction line tubes	p.	72
10.6.2.8	Evaporators and condensers	p.	73
10.6.2.9	Water tray	p.	73
10.6.2.10	Filter dryer	p.	73
10.6.2.11	System components brazing	p.	74
10.6.2.12	System evacuation	p.	74
10.6.2.13	Refrigerant charge	p.	74

10.6.2.14	Maximum refrigerant charge.....	p.	75
10.6.2.15	Leak control.....	p.	75
10.7.	Capillary tubes size	p.	76
10.7.1	Suggested capillary for preliminary selection	p.	76
	<i>Table 10.7.1a R600a LBP Applications.....</i>	<i>p.</i>	<i>76</i>
	<i>Table 10.7.1b R600a HBP applications</i>	<i>p.</i>	<i>77</i>
	<i>Table 10.7.1c R134a LBP applications.....</i>	<i>p.</i>	<i>77</i>
	<i>Table 10.7.1d R134a HBP Applications</i>	<i>p.</i>	<i>78</i>
	<i>Table 10.7.1e R290 - R404A - R507A LBP applications.....</i>	<i>p.</i>	<i>78</i>
	<i>Table 10.7.1f R290 - R404A - R507A - R407C M/HBP application</i>	<i>p.</i>	<i>79</i>
10.8	Rubber grommets and sleeves.....	p.	80
10.8.1	Rubber grommets assembly.....	p.	81
	<i>Figure 10.8.1 Rubber grommets assembling scheme</i>	<i>p.</i>	<i>81</i>
10.8.2	Rubber grommets/sleeves dimension	p.	81
	<i>Table 10.8.2 Rubber grommets/sleeves dimensions.....</i>	<i>p.</i>	<i>81</i>
	<i>Figure 10.8.2 Rubber grommets and sleeves</i>	<i>p.</i>	<i>82</i>
10.9	Rotolock valves	p.	83
10.9.1	Rotolock tightening torques.....	p.	83
	<i>Table 10.9.1 Recommended tightening torques.....</i>	<i>p.</i>	<i>83</i>
	<i>Figure 10.9.1 Rotolock valve types.....</i>	<i>p.</i>	<i>84</i>
10.9.2	Valve system position	p.	84
	<i>Figure 10.9.2 Valves position</i>	<i>p.</i>	<i>84</i>
10.10	Electric supply.....	p.	85
10.10.1	Supply voltage admitted limits.....	p.	85
10.10.2	Preliminary selection of fuses.....	p.	85
11	RUNNING DATA AND COMPRESSOR CHECKING PROCEDURES .	p.	86
11.1	Minimum compressor temperature	p.	86
11.2	Maximum temperature of electric motor windings	p.	86
11.3	Maximum discharge gas temperature.....	p.	87
11.4	Maximum discharge gas pressures and temperatures.....	p.	88
	<i>Table 11.4 Discharge gas maximum pressures/temperature</i>	<i>p.</i>	<i>88</i>
11.5	Suction gas overheating	p.	89
11.6	Compressor operating fields.....	p.	89
11.6.1	Compressors admitted operating fields.....	p.	89
	<i>Figure 11.6.1 Compressor approved operating fields.....</i>	<i>p.</i>	<i>90</i>
11.6.2	Start conditions.....	p.	91
	<i>Table 11.6.2 Temperature conditions corresponding to balanced and unbalanced pressures.....</i>	<i>p.</i>	<i>91</i>
11.6.2.1	Notes on starting pressures.....	p.	92
11.6.3	Use of transformer to raise the voltage.....	p.	92
11.6.4	Compressor cycling.....	p.	93
11.6.5	Running time	p.	93
11.6.6	Hot gas defrost	p.	94

12	COMPRESSOR CONTROL PROCEDURES	p. 94
12.1	Troubleshooting and service chart	p. 95
	<i>Table 12.1 Troubleshooting and service chart.....</i>	<i>p. 96</i>
13	ELECTRIC CIRCUITS CONTROL	p. 99
13.1.1	Version RSIR - RSCR with PTC starting device	p. 99
13.1.2	Version RSCR with TSD starting device.....	p. 100
13.1.3	Version RSIR with terminal board and current relay starting device..	p.101
13.1.4	Version CSIR American version and current relay starting device	p.102
13.1.5	Version CSIR Terminal board and current relay starting device	p.103
13.1.6	Version CSR/CSIR box with external overload protector.....	p.104
13.1.7	Version CSR/CSIR box with internal overload protector	p.105
13.1.8	Version PSC with internal or external overload protector.....	p.106
13.1.9	Version 3-phase internal overload protector.....	p.107
13.1.10	Version 3-phase internal + external overload protector	p.108
13.2	Control procedures	p.109
13.2.1	Control of electric motor (stator) windings.....	p.109
13.2.2	Control of stator windings ohmic resistance	p.109
13.2.3	Control of start and run capacitors.....	p.109
14	COMPRESSOR REMOVAL AND REPLACEMENT	p.110
14.1	Compressor removal and replacement - HFCs models	p.110
14.1.1	Compressor removal procedure	p.110
14.1.2	Compressor replacement procedure	p.112
14.2	Compressor removal and replacement - R600a and R290 models....	p.113
14.2.1	Preventive actions to be adopted	p.113
14.2.2	Failure diagnosis	p.114
14.2.3	Compressor removal	p.114
	<i>Figure 14.2.3a HCs refrigerant venting</i>	<i>p. 115</i>
14.2.4	System washing by OFDN procedure	p.115
14.2.5	Installing a new compressor.....	p.116
14.2.6	System vacuum, charging and sealing	p.116
14.2.7	Repaired cabinet verification.....	p.117
14.2.8	Retrofitting	p.117
15	COMPRESSOR DISPOSAL.....	p.117
16	HOW TO RETURN SUPPLIED PRODUCTS TO EMBRACO EUROPE.....	p.118
17	TESTS ON THE CUSTOMER APPLICATIONS.....	p.119
	APPENDIX	p.119
	DIGITAL TOOLS.....	p. 123

Revision 1 - May 2020

1. Chapter 6.1.1 : Notes on electrical components assembly
added note about position of electrical box in the appliance, distance from the appliance wall (safety note)

2. Chapter 10.6.1.5 : Embraco compressor max refrigerants charge
added technical limit of Hydrocarbons + note

ACRONYMS USED IN THE TEXT

AB: Alkyl Benzene

ANSI: American National Standards Institute

ASHRAE: American Society of Heating,
Refrigerating and Air Conditioning Engineers

ATEL: Acute-toxicity Exposure Limit

AHRI: Air-Conditioning, Heating and Refrigeration
Institute (formerly)

ATEX: Atmosphères Explosibles (Directive 94/9/EC)

CSIR: Capacitive Start - Inductive Run

CSR (CSCR): Capacitive Start & Run (Capacitor
Start - Capacitor Run)

DIN: Deutsches Institut für Normung

ELCOM: Electrical Component

EN: European Standards

EPA: Environmental Protection Agency

Ex: Mark for ATEX certified electrical equipment
for explosive atmospheres

F: Fan Cooling

FLA: Full Load Amps

GWP: Global Warming Potential

HBP: High Back Pressure

HC: Hydrocarbon

HCFC: HydroChloroFluoroCarbon

HFC: HydroFluoroCarbon

HGD: Hot Gas Defrost

HH: Household Application

HST: High Starting Torque

ID: Internal Diameter

IP: International Protection (ratings)

ISO: International Organization of Standardization

IPRV: Internal Pressure Relief Valve

LFL: Lower Flammability Limit

LRA: Locked Rotor Amps

LST: Low Starting Torque

LVD: Low Voltage Directive

MBP: Medium Back Pressure

MCC: Maximum Continuous Current

MD: Machine Directive

MSDSs: Material Safety Data Sheets

NS: American National Thread-Special

OD: Outside Diameter

ODL: Oxygen Deprivation Limit

OFDN: Oxygen-Free-Dry-Nitrogen

OLP: Overload Protector

PED: Pressure Equipment Directive

PTC: Positive Temperature Coefficient

POE: Polyolester

REACH: Regulation on Registration, Evaluation,
Authorization and Restriction of Chemicals

RLA: Rated Load Amperage

RSIR: Resistance Start - Inductive Run

RoHS: Restriction of Hazardous Substances
Directive

RSCR: Resistance Start - Capacitive Run

S: Static Cooling

SAE: Society for Automobile Engineer

TXV: Thermostatic Expansion Valve

UL: Underwriters Laboratories

3Ø: Three-phase

Terms and Definitions

For the refrigeration system terms used in this Installation Instructions, refer to EN 378-1 or similar standards.

1. SAFETY

1.1 SAFETY NOTICE

Embraco compressors are designed, manufactured and inspected according to the latest International applicable standards, with particular care on the user's safety.

Embraco compressors are designed as refrigerant pumping elements on refrigeration machines. Only if they are used for this purpose and installed according to the instructions of this Installation Instructions and to the applicable regulations and standards can be put in service, as indicated on the Embraco Manufacturers Declaration of Incorporation according the 2006/42/EC Machinery Directive.

For details contact Embraco Technical support team.

Only qualified/certified and authorized refrigeration technicians are allowed to perform installation and maintenance of the Embraco compressors; the electrical connections must be made by qualified electrical technicians.

Technicians are strongly advised to follow all the applicable International and National laws and regulation as well as the instructions of this Installation Instructions.

1.2 SAFETY ADVICE



WARNING: Indicates Instructions that may result in personal injury or death and property damage if not carefully followed.



CAUTION: indicates instructions that may results in property damage and possible personal injury if not carefully followed.



IMPORTANT: indicates instruction to avoid damages/malfunction of the compressors.

2. COMPRESSOR APPLICABLE STANDARDS AND REGULATIONS

ASTM B117:	Standard Practice for Operating Salt Spray (Fog) Apparatus
ANSI/ASHRAE 34 (*):	Designation and Safety Classification of Refrigerants
ISO817 (*):	Refrigerants - Designation and safety classification
EN 378-1 (*):	Refrigerating systems and heat pumps. Safety and environmental requirements
EN 378-4 (*):	Refrigerating systems and heat pumps. Safety and environmental requirements
EN 60079-15:	Explosive atmospheres. Electrical installations inspection and maintenance
EN 60999-1 (*):	Connecting devices - Electrical copper conductors - Safety
EN 60335-1 :	Household and similar electrical appliances. Safety. General requirements
EN 60335-2-34:	Household and similar electrical appliances. Safety. Particular requirements for motor-compressors
EN 60335-2-89(*):	Household and similar electrical appliances. Safety. Particular requirements for commercial refrigerating appliances with an incorporated or remote refrigerant unit or compressor
EN 60529 (*):	Degrees of protection provided by enclosures (IP Code)
UL 60335-1:	Safety of Household and Similar Appliances, General Requirements
UL 60335-2-34:	Safety of Household and Similar Electrical Appliances. Particular Requirements for Motor-Compressor

- Low Voltage Directive 2014/35/EU
- Machinery Directive 2006/42/EC
- Pressure Equipment Directive (PED) 2014/68/UE
- RoHS II Directive 2011/65/EU
- REACH Regulation (EC) 1907/2006

(Refer to the latest publication dates)

(*) Standards marked with this symbol are used as a reference during product development or as a reference for customers to check additional information.

2.1 PED CATEGORY II

2.1.1 COMPRESSOR LABEL FOR PED II

NJX compressor models with R290 (propane) refrigerant are approved for PED category II according to Pressure Equipment Directive (PED) 2014/68/EU. Label intended for PED category II contains following additional information:

Figure 2.1.1 Compressor label for PED II

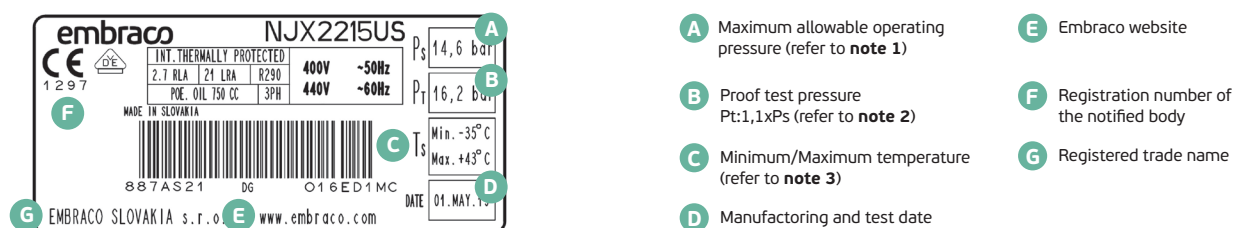

All the other fields remain the same as for another labels described in **Chapter 5**.

2.1.2 SPECIFICATION

The maximum internal free volume of the NJX propane compressors models is 4,4 liters.

The oil charge is considered as part of free volume.

Note 1: NJX housing of the hermetic compressor is subjected to low pressure side of the refrigeration system.

Note 2: Embraco is checking the compressor housing and its components for any indication of leaks (hermetic sealing test after the peripheral welding) applying a test pressure ($P_t = 1,1 \times P_s$), which is in accordance with PED II requirements, according to standard EN 14276-1. For verification of the strength of the hermetic compressor housing after peripheral welding, additional burst tests (hydrostatic tests) are performed regularly.

Note 3: Compressor housing shall not be exposed to the temperatures below -35°C as material mechanical characteristics are not guaranteed below this temperature. Embraco compressors are designed to operate at maximum ambient temperature of $+43^\circ\text{C}$.

3. EMBRACO COMPRESSOR RELEVANT DOCUMENTS

1. **Embraco Product catalogue** on www.embraco.com
2. **Installation Instructions**

Check available documents on the www.embraco.com, or contact Embraco Technical support team.

4. COMPRESSOR RANGE

The available models for the different applications and refrigerants, cooling capacity, energy consumption and the approved electrical components, are listed in the **Embraco Product catalogue** on www.embraco.com

4.1 APPLICATION DESCRIPTION



Each model of motor-compressor is intended for specific refrigerant and application. Their use in different application and/or with different refrigerant may result in significant impact to motor-compressor performance, life expectancy or even may result in personal injury and damages.

Table 4.1 Applications

COMPRESSOR TYPE	DESCRIPTION
ULBP (*)	(Ultra Low Back Pressure) Models for very low evaporating temperatures, suitable for applications with working evaporating temperatures between -95°C to -65°C; for instance: medical appliances.
LBP (*)	(Low Back Pressure) Models for low evaporating temperatures, suitable for applications with working evaporating temperatures lower than - 20°C; for instance: chest freezers, frozen food cabinets, frozen food display cases, upright freezers, etc.
L/MBP (*)	(Low/Medium Back Pressure) Models for low/medium evaporating temperatures, suitable for applications with working evaporating temperatures between - 35°C and 0°C; for instance: professional kitchen coolers, ice cream freezers, bottle coolers, chest freezers, etc.
MBP (*)	(Medium Back Pressure) Models for medium evaporating temperatures, suitable for applications with working evaporating temperatures higher than -20°C; such as fresh food cabinets, drink dispenser, bottle coolers, ice makers, etc.
HBP (*)	(High Back Pressure) Models for high evaporating temperatures, suitable for applications with working evaporating temperatures higher than -15°C; such as fresh food cabinets, drink coolers, ice makers, dehumidifiers, dryers, etc.
AC	(Air Conditioning) Models for air conditioning, suitable for applications with positive working evaporating temperatures, such as air conditioners, heat pumps and dehumidifiers.

(*) See *Figure 11.6.1* - Compressor admitted operating fields

See the available compressor models in the **Embraco Product catalogue** on www.embraco.com

4.2 STARTING TORQUE CLASSIFICATION

Table 4.2 Electrical motor starting torque classification

TYPE	DESCRIPTION
LST (*)	(Low Starting Torque compressors) These compressors adopt low starting torque electric motor types RSIR – RSCR - PSC and are suitable for systems with balanced pressures at the compressor start up (capillary tube or other expansion devices that allow balanced pressure during off cycle).
HST (*)	(High Starting Torque compressors) These compressors adopt high starting torque motor type CSIR - CSCR (start capacitor is mandatory) and are suitable for systems with expansion valve or capillary, with unbalanced pressures at the compressor start up (as well as for systems with balanced pressure at the start up).

(*) See *Table 4.4* - Minimum starting voltage and *Chapter 11.6.2* - Start conditions.

4.3 ELECTRICAL MOTOR TYPES



Each compressor model has specific electrical components, indicated on the compressor Technical datasheet in the **Embraco Product catalogue** on www.embraco.com

Avoid usage of different components.

Table 4.3 *Electrical motor types*

TYPE	DESCRIPTION
RSIR	<p>(Resistance Start Inductive Run)</p> <p>This motor type, used in the compressor of small power, has a low starting torque (LST) and must be applied on systems with balanced pressures at the compressor start up (capillary tube or other expansion devices that allow balanced pressure during off cycle).. The motor is characterized by a start winding with high ohm resistance that must be disconnected when the rotor reaches the stabilized rotational speed. An electromagnetic relay, calibrated for the specific motor current or a PTC - (Positive Temperature Coefficient) - solid state starting device, disconnects the start winding at the end of the startup.</p>
CSIR	<p>(Capacitive Start Inductive Run)</p> <p>This motor type has a start capacitor connected in series with the start winding when the compressor starts up. An electromagnetic relay, calibrated for the specific motor current, disconnects the start winding and start capacitor at the end of the startup. This motor has a high starting torque and can be used on systems where the compressor has to start at unbalanced pressure conditions.</p> <p> The similarity with the RSIR type is only apparent. It is not possible to transform a RSIR motor in CSIR ones just by adding a starting capacitor (except for the models with the electrical motor specifically designed for this option, for more information see Embraco Product catalogue on www.embraco.com</p>
RSCR	<p>(Resistance Start Capacitive Run)</p> <p>Similar to RSIR motor version but uses a PTC solid state starting device and a permanent connected run capacitor to improve its efficiency. This type of motor has a low starting torque and must be used, as the RSIR, with system adopting a capillary tube (or pressure equalizer device) where the pressure equalize before compressor start up. This motor has high efficiency and high $\cos\phi$.</p>
PSC	<p>(Permanent Split Capacitor)</p> <p>This motor is characterized by the run capacitor permanently connected in series with the start winding; both running and start winding remain connected even after the motor starts. This type of motor doesn't need a starting device; it has a low starting torque and must be used with systems adopting a capillary tube (or a pressure equalizer device) where the pressure equalize before compressor start up. These motors have high efficiency and high $\cos\phi$.</p>
CSR (CSCR)	<p>(Capacitive Start & Run - Capacitor Start Capacitor Run)</p> <p>This motor has a start capacitor and a run capacitor. The start capacitor is connected in parallel with the run capacitor during the compressor start-up and it is disconnected by a starting relay (voltage type) at the end of the starting; the run capacitor is permanently connected in series with the start winding. Both running and start windings remain connected even after the motor starts. This motor has a high starting torque and can be used on systems where the compressor has to start at unbalanced pressure conditions; it has high efficiency and high $\cos\phi$.</p>
3Ø	<p>(Three-phase)</p> <p>Three-phase winding with star connections, this motor doesn't need a starting device and has a high starting torque.</p>

4.4 ELECTRICAL MOTOR VOLTAGES AND FREQUENCIES



Operation of motor-compressor at different voltage range than assigned (marked on the label) may result in improper function of motor-compressor, missing actuation of overload protection or even to damage of motor-compressor and/or its accessories.

Note: Not all voltages and frequencies listed in Table 4.4, are available on all compressor models. For the availability of different voltages and frequencies for each model consult the **Embraco Product catalogue** on www.embraco.com

Table 4.4 Compressor voltages & frequencies, operating voltage range and minimum starting voltage

Voltage Code	Rated Voltage & Frequency (1)	Voltage Working Range (*)		Minimum Start Voltage (*) (**)	
		50Hz	60Hz	50Hz	60Hz
A	220 - 240V 50Hz 1~	198V ÷ 254V		187V	
B	200 - 230V 50Hz / 208 - 230V 60Hz 1~	180V ÷ 244V	187V ÷ 244V	170V	177V
C	220V 50Hz 1~	200V ÷ 242V		187V	
D	208 - 230V 60Hz 1~		187V ÷ 244V		177V
E	115 - 127V 60Hz 1~		103V ÷ 134V		98V
F	100V 50Hz / 100 - 127V 60Hz 1~	90V ÷ 110V	90V ÷ 134V	85V	85V
G	115V 60Hz 1~		103V ÷ 127V		98V
I	220 - 240V 50/60Hz 1~	198V ÷ 254V	198V ÷ 254V	187V	187V
J	230V 60Hz 1~		207V ÷ 253V		195V
K	200 - 220V 50Hz / (230V 60Hz) 1~	180V ÷ 234V	207V ÷ 253V	170V	195V
M	380 - 420V 50Hz / 440 - 480V 60Hz 3~	332V ÷ 445V	396V ÷ 509V	323V	374V
N	200 - 240V 50Hz / 230V 60Hz 1~	180V ÷ 254V	207V ÷ 253V	170V	195V
P	380V 60Hz 3~		342V ÷ 418V		323V
Q	100V 50/60Hz 1~	90V ÷ 110V	90V ÷ 110V	85V	85V
R	200V 50/60Hz 3~	180V ÷ 220V	180V ÷ 220V	170V	170V
S***	400V 50Hz / 440V 60Hz 3~	360V ÷ 440V	396V ÷ 484V	340V	374V
T	220 - 230V 50Hz 1~	198V ÷ 244V		187V	
U	220V 60Hz 1~		200V ÷ 242V		187V
V	230V 50Hz 1~	207V ÷ 253V		195V	
W	220V 50/60Hz 1~	200V ÷ 242V	200V ÷ 242V	187V	187V
X	220 - 240V 50/60Hz 1~	150V (160V) ÷ 240V (2)		150V (160V) (2)	
Z	200 - 230V 60Hz 3~		180V ÷ 244V		170V

(1) Voltage/Frequency range indicated in brackets may not be valid for all models and may not be included in Agency approvals, contact Embraco Technical support team for availability.

(2) Depending on compressor family, for details contact Embraco Technical Support team.



(*) With compressor working or starting within the Table 11.6.1 and Table 11.6.2.

(**) Minimum starting voltage refers to the minimum voltage at the compressor pins during the compressor start. It does not represent the voltage at the power supply outlet.

(***) For specific model refer to datasheet or consult with Embraco Technical support team.

4.5 ELECTRICAL COMPONENTS TYPES

The electrical components specified for each Embraco compressor model are indicated in the Technical datasheet, available in the **Embraco Product catalogue** on www.embraco.com



The compressor must be equipped with the electrical components indicated in the Technical datasheet in the **Embraco Product catalogue** on www.embraco.com

The type of electrical components for each type of electric motor is indicated in *Table 4.5*, and is usually supplied as compressor equipment.

Only under some circumstances agreed with the customer, the electrical components can be excluded from the compressor supplied equipment; however the user must adopt the electrical components specified by Embraco.



Use of other electrical components than the ones approved by Embraco (listed in the Technical Datasheets and in **Embraco Product Catalogue** for each specific model) or their exclusion may damage the compressors and other parts and cause serious injury to persons.

Table 4.5 Electrical components types

TYPE OF MOTOR	Overload Protector (1)	STARTING DEVICE			CAPACITORS	
		Current Relay	Voltage Relay	PTC (or TSD)	Start	Run
RSIR	√	√(2)		√(2)		
RSCR	√			√		√
CSIR	√	√(3)	√(3)		√	
CSR (CSCR)	√		√		√	√
PSC	√					√
3Ø	√					

(1) Some models approved with Internal OLP, see details in the **Embraco Product catalogue** on www.embraco.com

(2) Certain RSIR compressor model adopts the starting current relay, other models adopt the PTC. To identify the adopted starting device refer to the **Embraco Product catalogue** on www.embraco.com

(3) Certain CSIR compressor model adopts the starting current relay, other models adopt voltage relays. To identify the adopted starting device refer to the **Embraco Product catalogue** on www.embraco.com

4.6 COMPRESSOR COOLING TYPES

According to their design and power the various compressor models require different cooling systems. The cooling system intended for each compressor model is indicated in the **Embraco Product catalogue** on www.embraco.com

For information on the proper installation and cooling of the compressor, see Chapter **10.1.3.7**.



Usage of insufficient cooling of motor-compressor in case of fan cooled version may result in:

- Increase of average temperature of motor, thus reducing life time of motor insulation.
- Overload protector recurrent actuations, with life time reduction of it and of other parts.
- Other negative impacts to the performance of motor-compressor and its parts.

Table 4.6 Cooling types

TYPE	DESCRIPTION
S	Static cooling: the compressor does not require forced ventilation cooling, but it must be installed so that the natural air circulation can adequately cool the compressors to avoid overheating.
F	Fan cooling: the compressor requires forced ventilation cooling through the use of a fan sized and installed as indicated in <i>Table 10.1.3.7</i> and <i>Figure 10.1.3.7</i> .



The specific cooling type and Air flow rate for each compressor is indicated in Embraco Catalog (see also *Table 10.1.3.7* – Fan cooler characteristic). It can influence the activation of Overload protector thus it must be observed to allow the correct running condition of the compressor.

5. COMPRESSOR NAMEPLATES, MODEL AND BILL OF MATERIAL CODE

5.1 COMPRESSOR LABEL

Figure 5.1 Compressor label

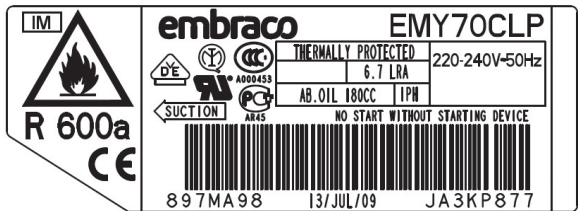
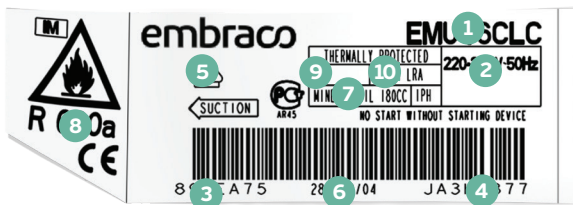
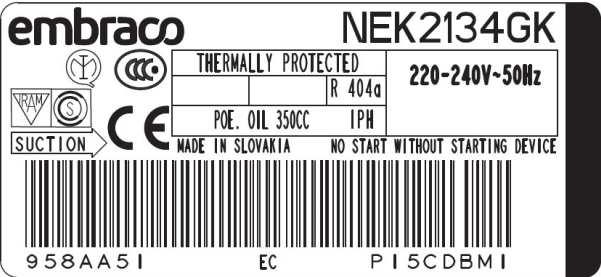

- 1 Compressor model
- 2 Supply Voltage
- 3 Bill of Materials code
- 4 Serial Number
- 5 Agency Approval Marks
- 6 Date code or Production date
- 7 Oil type and quantity
- 8 Refrigerant type
- 9 Current Consumption (Rated Load Amperage, when applicable)
- 10 Locked Rotor Amperage (when applicable)

5.2 COMPRESSOR MODEL CODE

The information for identification of the compressor model, voltage, refrigerant to be used are printed on the nameplate.

Figure 5.2.1 EM / NE / NT / NJ model code

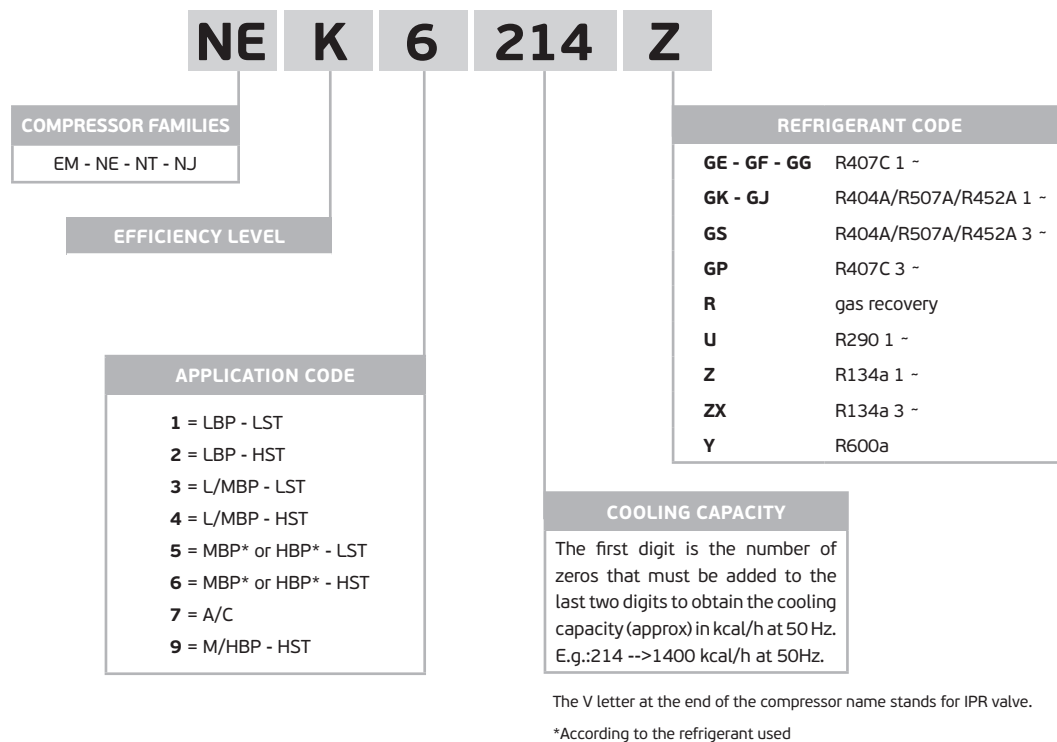
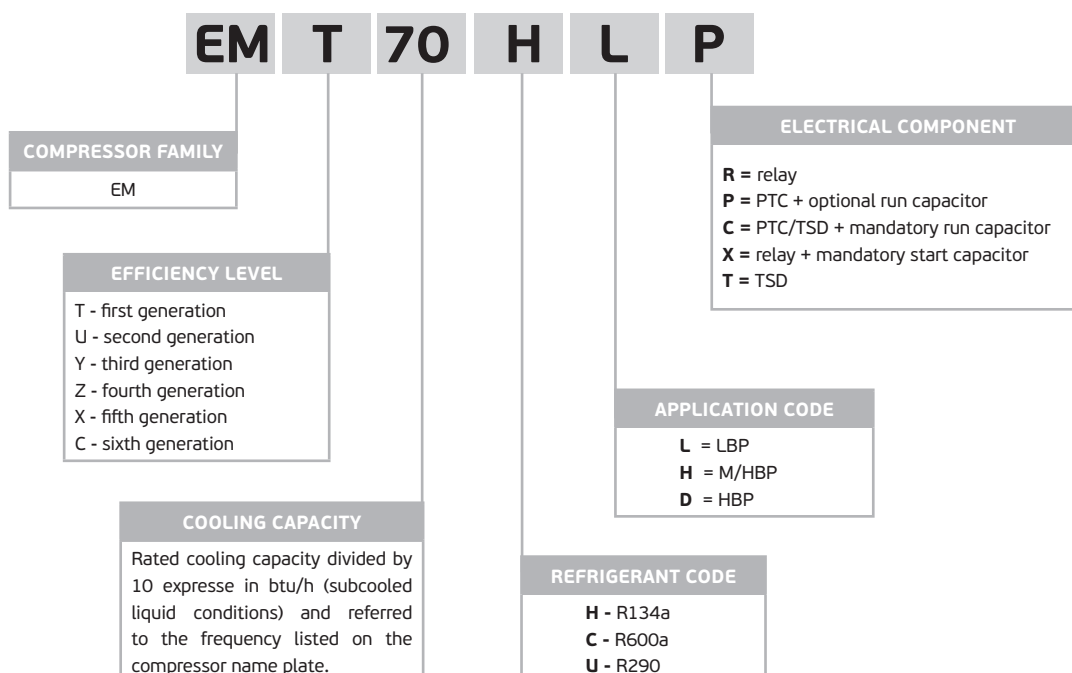
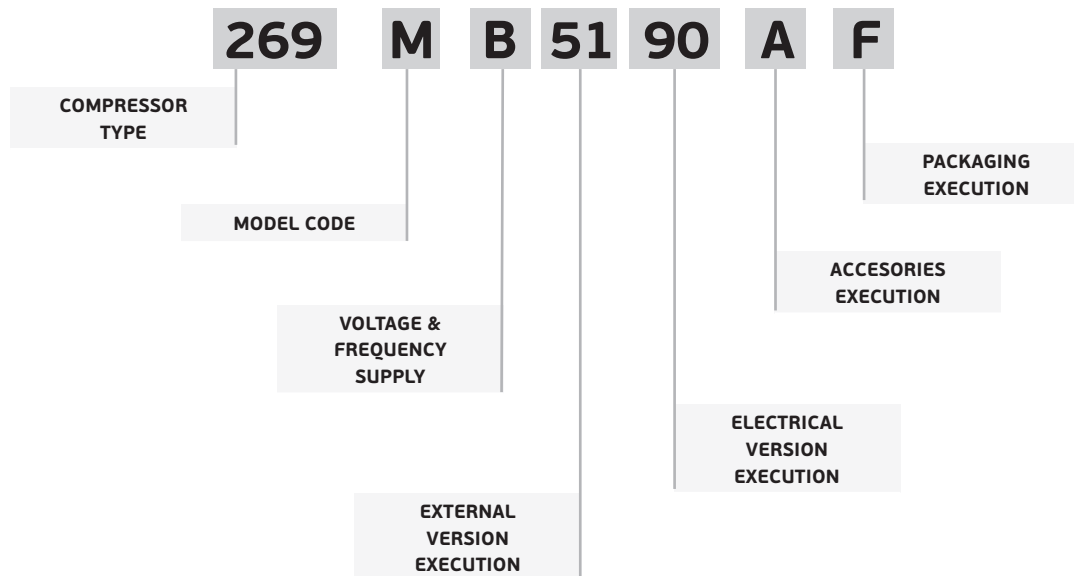

Figure 5.2.2 EM model code



5.3 COMPRESSOR BILL OF MATERIAL CODE

Figure 5.3



5.4 MANUFACTURING DATE CODE

Embraco production date is stated on compressor label in one of below 2 ways:

1. Full date description (example 13/Jul/16)
2. Coded date, see detail in below *Table 5.4*

Figure 5.4 *Date code*

Month	A	B	Year
	<i>From September to August of following year</i>		
A = September	M = 2000/2001	A = 2012/2013	
B = October	N = 2001/2002	B = 2013/2014	
C = November	P = 2002/2003	C = 2014/2015	
D = December	R = 2003/2004	D = 2015/2016	
E = January	S = 2004/2005	E = 2016/2017	
F = February	T = 2005/2006	F = 2017/2018	
G = March	U = 2006/2007	G = 2018/2019	
H = April	V = 2007/2008	H = 2019/2020	
J = May	W = 2008/2009	J = 2020/2021	
K = June	X = 2009/2010	K = 2021/2022	
L = July	Y = 2010/2011	L = 2022/2023	
M = August	Z = 2011/2012		

5.5 COMPRESSOR TEST CONDITION

Table 5.5 Test condition

TEST CONDITIONS (RATING POINT)	APPLICATION	EVAPORATING TEMPERATURE °C	CONDENSING TEMPERATURE °C	RETURN GAS TEMPERATURE °C	SUB-COOLING	LIQUID TEMPERATURE °C	AMBIENT TEMPERATURE °C
EN 12900	LBP	-35	40	20 ^(*)	NO SUB-COOLING	-	35
	MBP	-10	45				
	HBP	5	50				
ARI 540 (2004)	LBP	-23.3	48.9	4.4	NO SUB-COOLING	-	35
	MBP	-6.7	48.9	4.4			
	HBP	7.2	54.4	18.3	8.3K		
ARI 540 (2015)	LBP	-31.7	40.6	4.4	NO SUB-COOLING	-	35
	MBP	-6.7	43.3	18.3			
	HBP	7.2	54.4	18.3			
ASHRAE SUBCOOLED	LBP	-23.3	54.4	32.2	-	32.2	32.2
	MBP and HBP	7.2	54.4	35	8.3K	-	35
CECOMAF	LBP	-25	55	32	NO SUB-COOLING	-	32

6. WIRING DIAGRAMS

6.1 ELECTRICAL CONNECTIONS



The electrical connections to the compressor must be carried out according to the wiring diagrams indicated for each compressor model in the **Embraco Product catalogue** on www.embraco.com

A summary view of the connections is indicated in *Figure 6.1.b*.

Figure 6.1.a Wiring diagrams key





































	OVERLOAD PROTECTOR		PTC START DEVICE'
	OVERLOAD PROTECTOR		INTEGRATED PTC DEVICE
	CURRENT START RELAY		CURRENT START RELAY WITH CAPACITOR CONNECTIONS
	3CR CURRENT START RELAY		3ARR3 START RELAY (VOLTAGE).
	RUN CAPACITOR		RUN CAPACITOR (MANDATORY - NOT SUPPLIED)
	OPTIONAL RUN CAPACITOR		START CAPACITOR
	FAN		PUSH BUTTON
	LAMP		SINGLE PHASE MOTOR
	3-PHASE MOTOR		THERMOSTAT
	LOW-HIGH PRESSURE SWITCH		PILOT CIRCUIT 24 OR 220 V
	EARTH CONNECTION		COMMON (INTERNAL OVERLOAD PROTECTOR)
	3-PHASE SUPPLY		START
	SINGLE PHASE SUPPLY		BROWN CABLE
	COMMON		BLACK CABLE
	RUN		RED CABLE
	TERMINAL BLOCK		CONNECTIONS TO BE MADE BY THE CUSTOMER (NOT SUPPLIES)
	WHITE CABLE		
	BLUE CABLE		
	YELLOW-GREEN CABLE		
	CONNECTIONS SUPPLIED		

Figure 6.1b Wiring diagrams

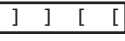
SM00 - EMT/NE SERIES RSIR PTC European Version



SM01 - EMT/NE SERIES RSCR PTC European Version

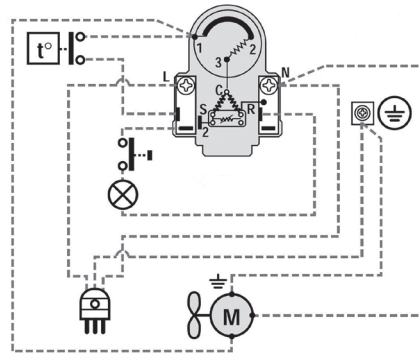
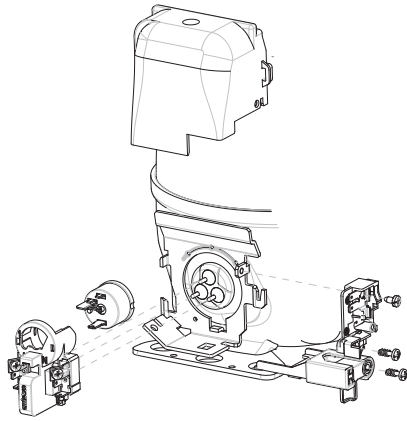
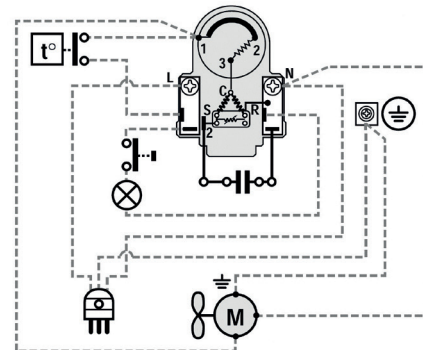
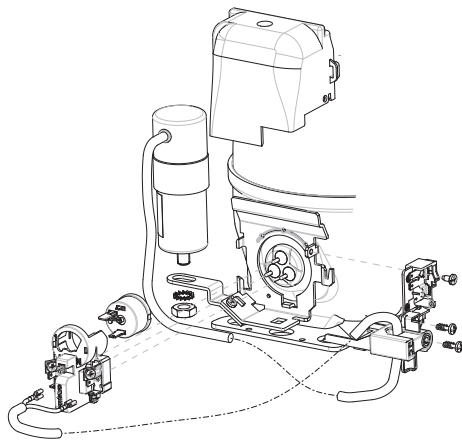

SM02 - EMT/NE SERIES RSCR TSD European Version

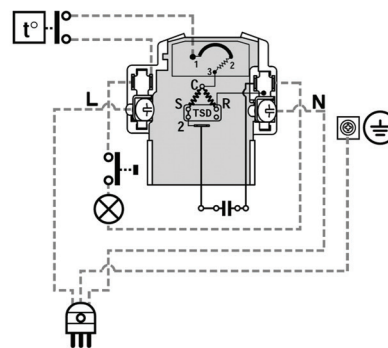
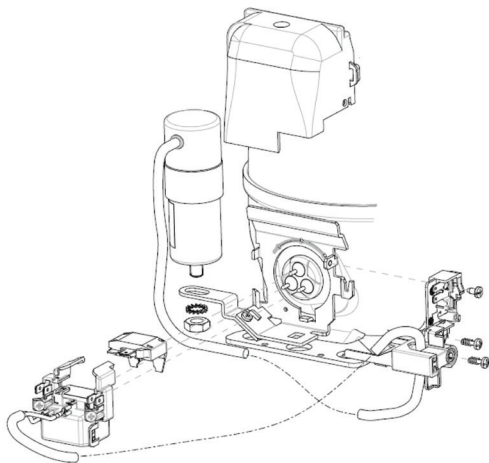

SM03 - EMT/NE SERIES RSIR Terminal Board & Start Device

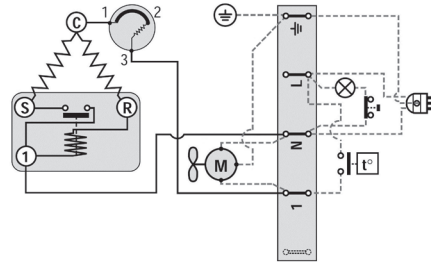
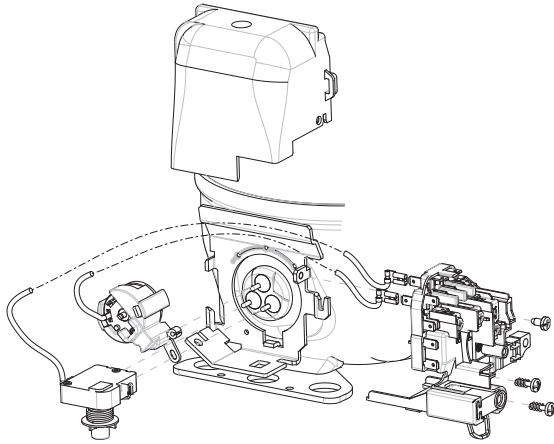

SM04 - EMT/NE SERIES CSIR American Version

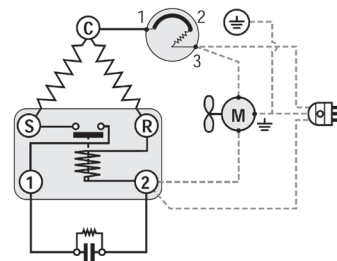
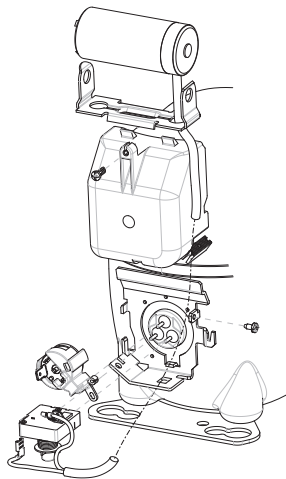

SM05 - EMT/NE SERIES CSIR Terminal Board & Start Device

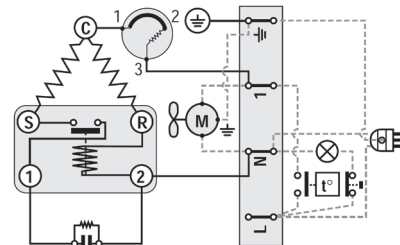
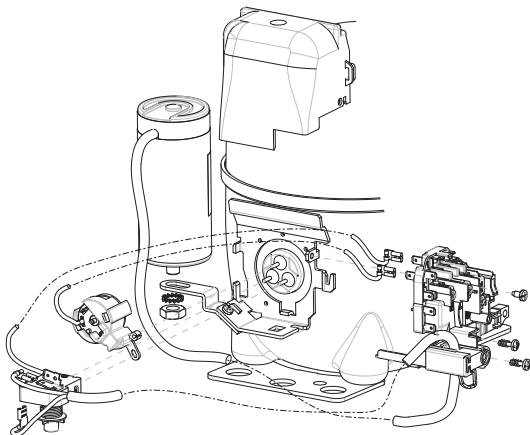

SM06 - NE SERIES CSR Box

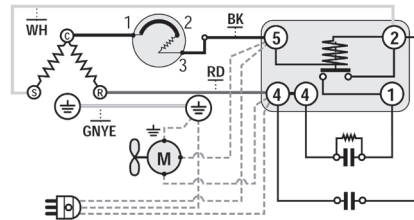
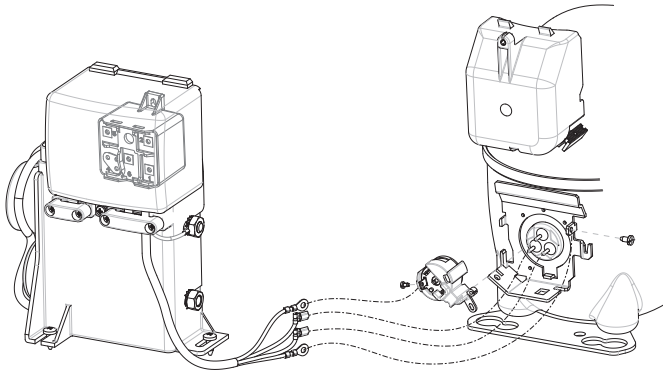

SM10 - NE SERIES CSR Box internal overload protector

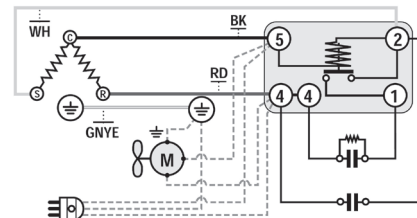
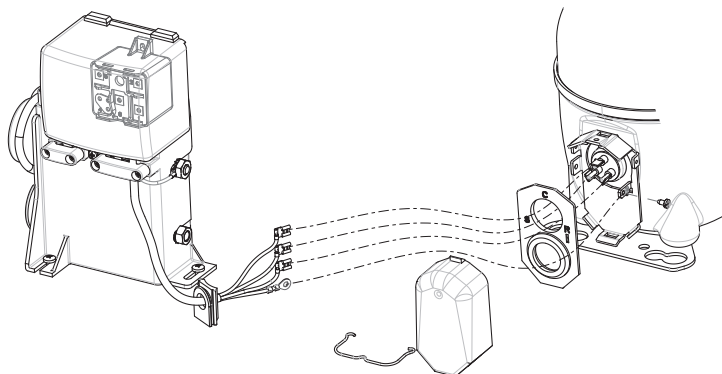

SM12 - NJ SERIES CSIR box External overload protector

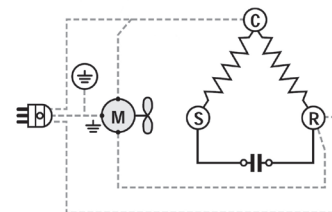
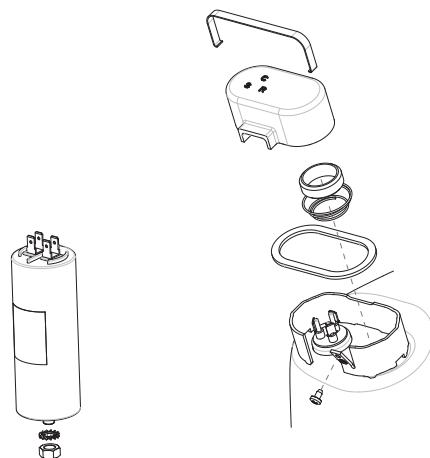

SM13 - NJ SERIES CSIR box External overload protector

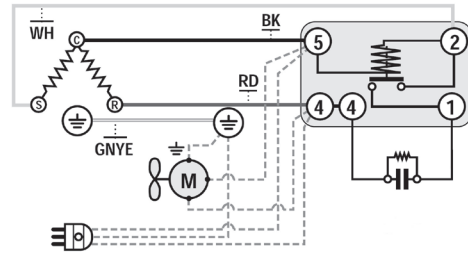
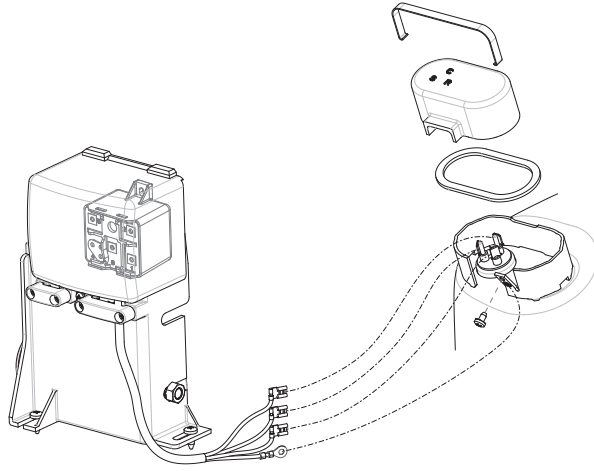

SM15 - NJ PSC

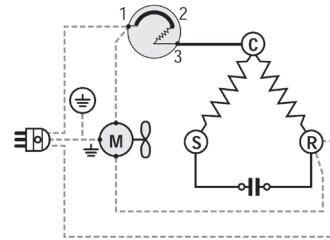
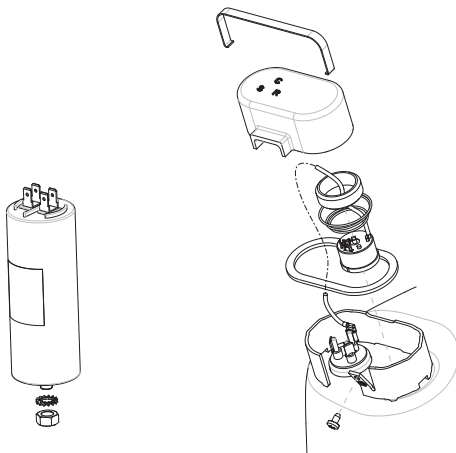

SM16 - NJ SERIES CSR Box (Internal Overload Protector)

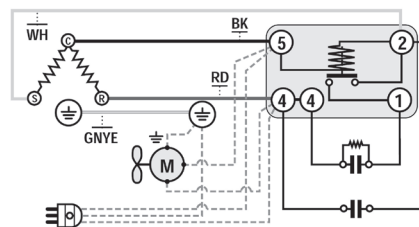
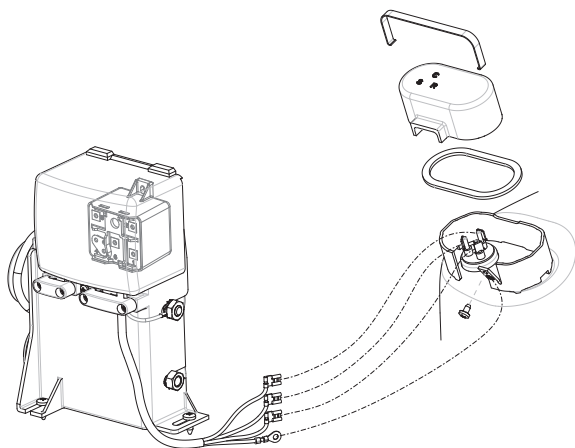

SM17 - NJ CSR Box (External Overload Protector)

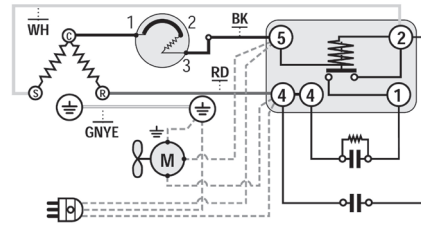
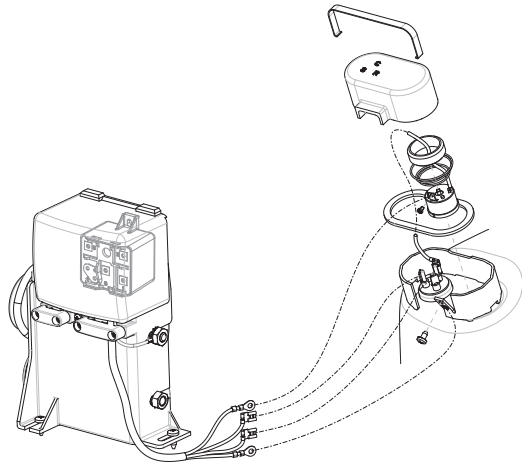

SM18 - NJ SERIES 3-Phase (Internal Overload Protector)

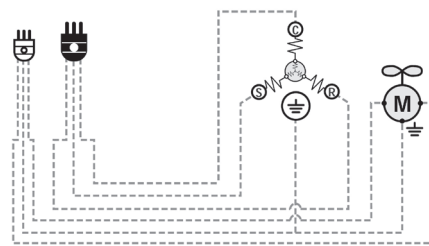
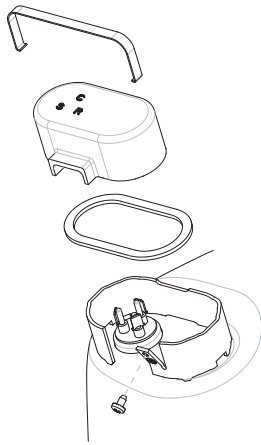

SM19 - NT SERIES CSIR Terminal Board

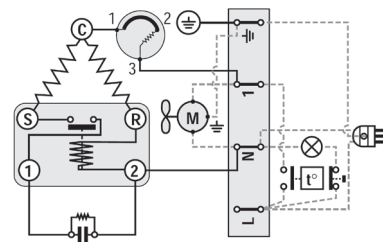
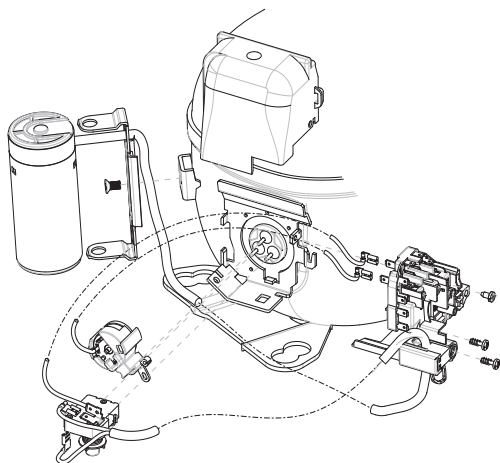

SM20 - NT SERIES CSIR – American Version

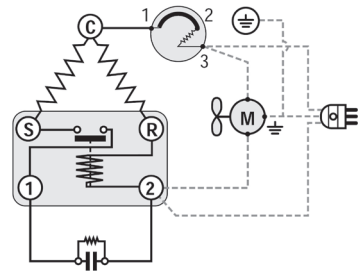

SM21 - NT SERIES CSR Box

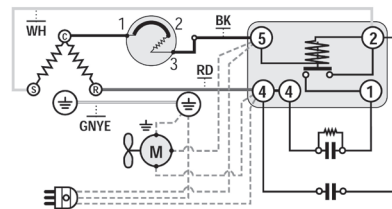
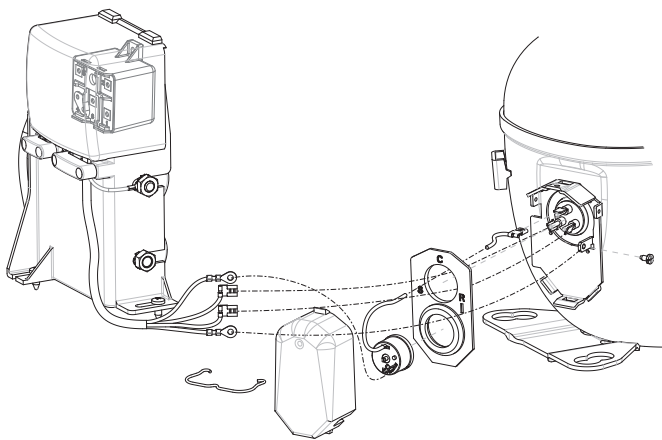

SM23 - NT SERIES CSR Box

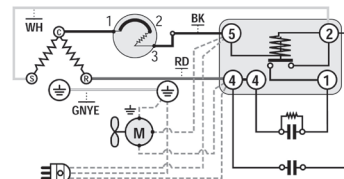
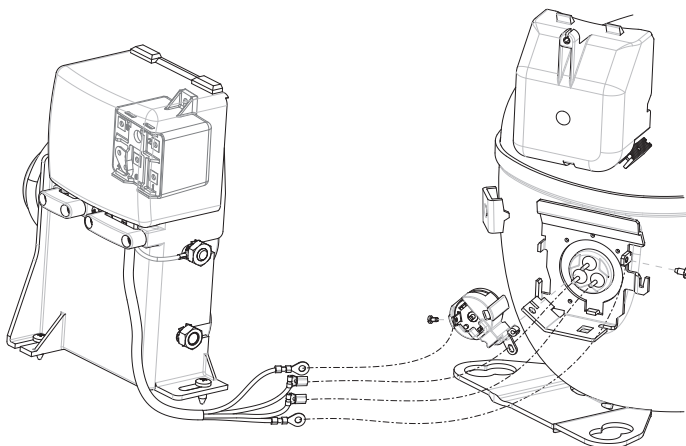

SM24 - NJ SERIES CSIR box External overload protector

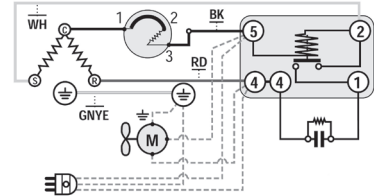
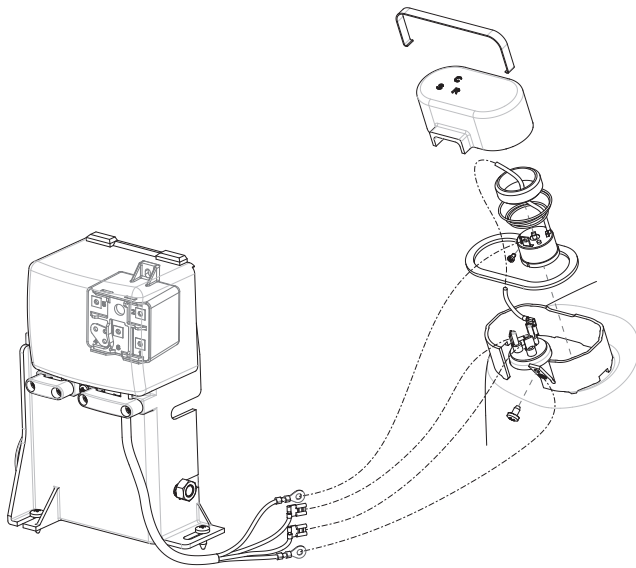

SM26 - NT SERIES CSR Box (Internal Overload Protector)

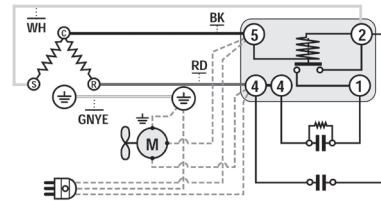
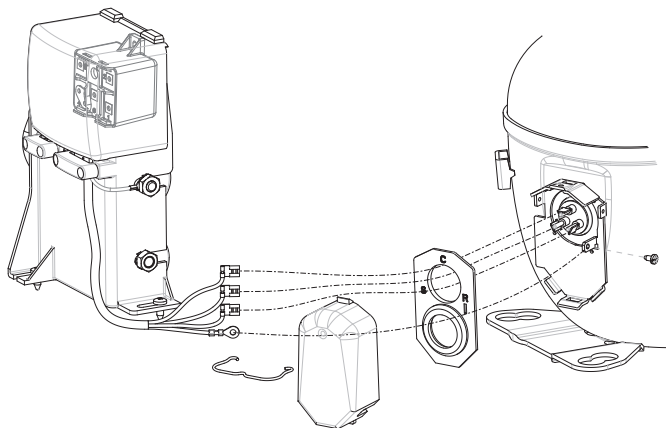

SM27 - NT SERIES 3-Phase (Internal + External Overload Protector)

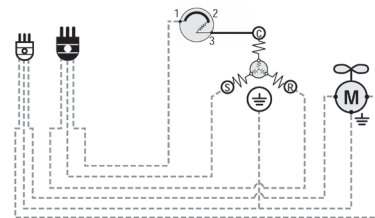
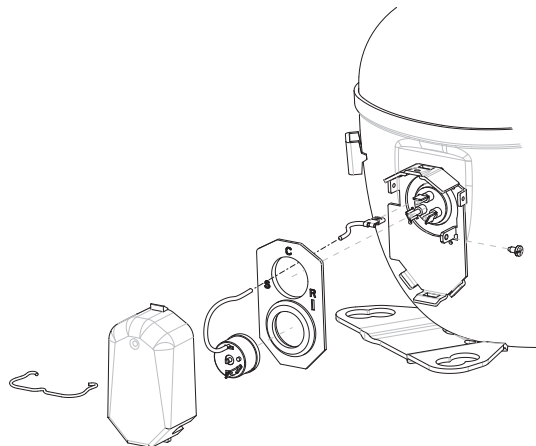

Notes on electrical component connections:

- RSIR/RSCR come with faston connection 4.8 mm
- CSIR come with terminal board with 6.3 mm external connections
- CSIR without terminal board come with relay and OLP with 6.3 mm faston
- CSR boxes come with screw connections placed on voltage starting relays (except for High IP degree full plastic cover CSR boxes which come with 6.3 mm faston terminal board).

6.1.1 NOTES ON ELECTRICAL COMPONENTS ASSEMBLY



Avoid excessive shocks on the pins of the compressor. The force to insert the terminals of the electrical components or supply line must be along the axis of pins: transversal forces not aligned with the pins or moments exerted on the pins can bend them or cause cracks in the glass insulation. These cracks can lead to glass breaks, refrigerant/oil leakages and short circuits. This situation is particularly dangerous in case of use of HCs refrigerants, as there is a risk of flammable refrigerant leak, leading to an electrical arc that could trigger a flame.



Avoid to use the electrical components to get multiple connections on their terminals: the excessive force necessary to fix all them together may damage the components. If multiple connections are needed, use the terminal board provided by Embraco for its compressors or other external terminal boards (complying with the electrical safety standards) to be fix on the cabinet. For other solutions, contact Embraco Technical Support team.



Position of electrical box in the application - is mandatory to be in vertical direction, to assure correct functionality of relay, as indicated by arrows and sign SIDE UP situated in the upper part of electrical box (see *Figure 6.1.1*).

Position of electrical box in the application - it is mandatory to assure min 15 mm distance from the application wall, to provide S2 safety protection opening of capacitors. Electric box cannot be used in an open niche application. (It is not a direct access assembly.)

Figure 6.1.1 Electrical box mounting position

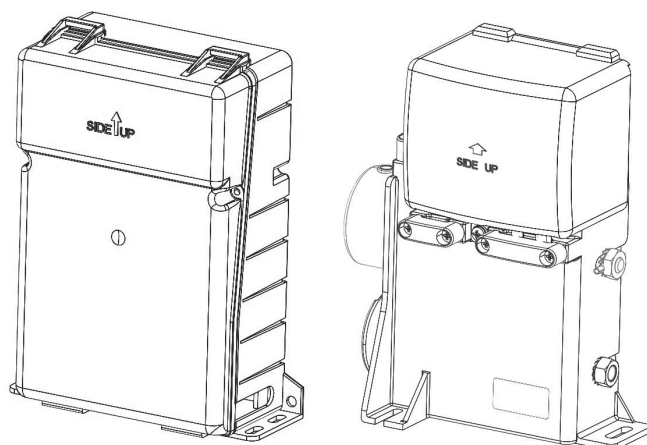

6.2 COMPRESSOR PIN POSITION

Figure 6.2.1
EM / NE / NT / NJ models
pin position

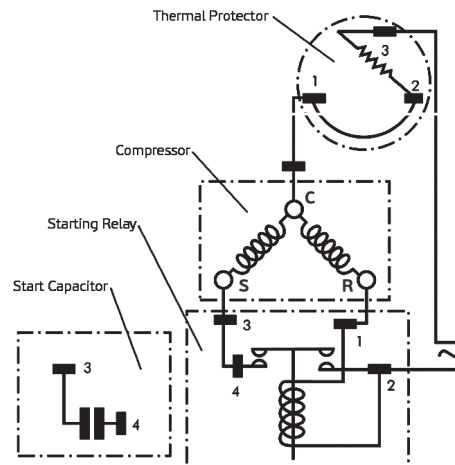

6.3 SCREW CLAMPING TORQUE OF SUPPLIED COMPONENTS

In order to facilitate their unscrewing, the connection screws on overload protectors, current relays, terminal boxes and ground plates are supplied with a clamping torque of $0.1 \div 0.3 \text{ Nm}$ ($1 \div 3 \text{ kgcm}$). Voltage relays are supplied with clamping torque of $0.1 \div 0.4 \text{ Nm}$ ($1 \div 4 \text{ kgcm}$).

6.4 SCREW FINAL TIGHTENING

For the final tightening of the connections on the compressor electrical components and terminals made at the installation of the compressor on the refrigeration system, a torque of $0.8 \div 1.4 \text{ Nm}$ ($8 \div 14 \text{ kgcm}$) should be applied to the screws. The final clamping torque of electrical connections screw terminals shall be compliant with the EN 60999-1 and part 2 for household and similar appliances.

6.5 QUICK CONNECTION (FASTON)

In order to assure firm connection between electrical accessories and the refrigeration system, it is necessary to use suitable type of terminals. In case of quick connect terminals recommended material is phosphorus bronze.

7. COMPRESSOR SUPPLY CONDITIONS

7.1 COMPRESSOR PERFORMANCE

The various models are supplied with performance and tolerances indicated in the **Embraco Product catalogue** on www.embraco.com

7.2 COMPRESSOR EXTERNAL VIEWS

The compressor external view (size, tubes diameters, mounting base) of the various models are indicated in the **Embraco Product catalogue** on www.embraco.com

7.3 ELECTRICAL INSULATION

All compressors are tested for dielectric strength and electrical insulation to ground according to requirements of the following standards (latest edition):

- EN 60335-2-34 (to be used with EN 60335-1)
- UL 60335-2-34 (to be used with UL 60335-1)

Note: dielectric strength and compressor insulation to ground are different when the compressor is tested in the air or in a system charged with refrigerant, due to the dielectric characteristics of the refrigerant.



When motor-compressor is under vacuum, do not carry out any evaluation or test of the insulation (dielectric strength or hi-pot test) using voltage AC or DC. It may result in damages of the insulation system and, consequently, in shortening the insulation life.

7.4 COMPRESSOR APPROVALS BY SAFETY INSTITUTES

The safety approvals granted for the various compressor models are indicated in the **Embraco Product catalogue** on www.embraco.com

7.5 "IP" DEGREE OF PROTECTION

The degree of protection provided by the terminal cover and the assembly of the electrical components supplied with the compressor are listed in *Table 7.5*, in accordance with the EN 60529 standard.

Table 7.5 IP Degree

SERIES	EM - NE - NT (*) (**)	NJ (**)
"IP" DEGREE	IP 32	IP 33

(*) NT with vertical terminal fence (*Figure 7.5.a*) has IP 33.

(**) Specific NE/NT/NJ are available on demand with IP 34 CSR box (*Figure 7.5.c*).

Figure 7.5.a NT with vertical terminal fence (IP33)

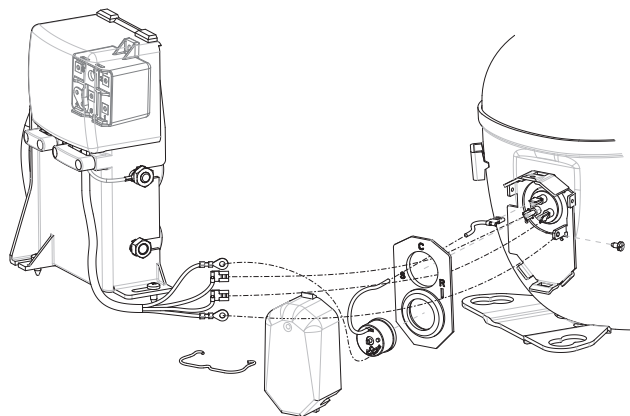

Figure 7.5.b NT with horizontal terminal fence (IP32)

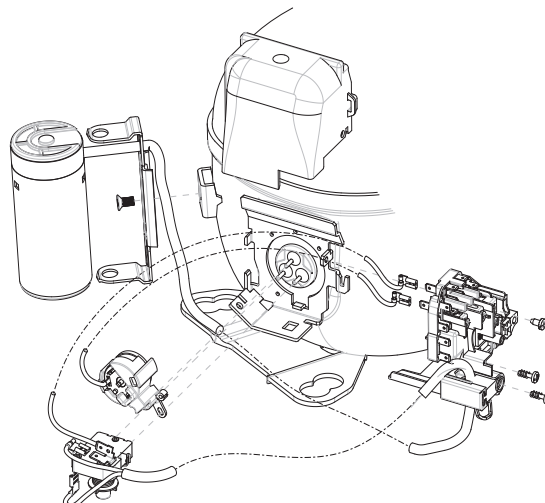
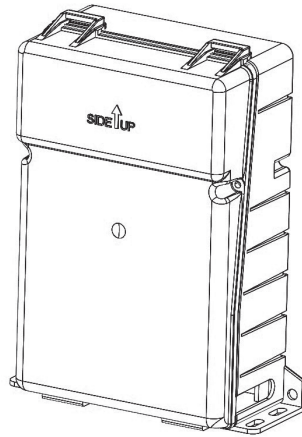

Figure 7.5.c CSR box with IP34



7.6 COMPRESSOR SHELL HYDROSTATIC STRENGTH

The compressor shell resists pressures above those prescribed in the standards:

- EN 60335-2-34
- UL 60335-2-34

7.7 DEHYDRATION

The Embraco compressors have a drying process on their production line, before receiving the oil charge. The residual humidity after drying is according to the *Table 7.7*.

Table 7.7 Maximum level of residual humidity (H₂O mg)

SERIES	RESIDUAL HUMIDITY MAXIMUM AMOUNT (H ₂ O mg)
EM - NE	60
NT	80
NJ	90

7.8 PAINTING

The compressor paint resists corrosion for the exposure of salt spray of 96 hours according to ASTM B117. The compressors are supplied with the tube ends and the hermetic terminals (compressor pins) unpainted.

7.9 COMPRESSOR PRESSURIZATION

Compressors are delivered pressurized to a pressure of about 1 bar with dry air (dew point lower than -40°C), or with light vacuum, depending on models and refrigerants. For further details contact Embraco Technical support team.

The compressor tubes are sealed with caps to avoid contamination by external air and humidity entering inside the compressor.

7.10 OIL CHARGE

The quantity and type of oil charged into the compressors are indicated in the compressor Technical datasheet in the **Embraco Product catalogue** on www.embraco.com

A colored "O" stamped on the compressor cover indicates the presence and type of oil, for more information see *Table 7.10*.

Oil type and oil quantity is indicated on compressor label.

The maximum humidity content in the oil, before being charged in the compressor, is 40 ppm.

Table 7.10 Lubricant oils approved for compressors

FAMILY	REFRIGERANTS						OIL TYPE	COMPOSITION	VISCOSITY GRADE	COMMERCIAL NAME	STAMP
	R134A	R404A	R290	R600a	R407C	R422D					
EM SK	x		x				Polyolester	POE	ISO 10	EMKARATE RL 10H	Red
				x			Alkylbenzene	AB	ISO 5	Q-SOL LAB-SY	Yellow
				x			Alkylbenzene	AB	ISO 2	ZEROL 2T	Red
EM IT	x	x	x	x only HBP			Polyolester	POE	ISO 22	EMKARATE RL 22H	White
				x only HH			Alkylbenzene	AB	ISO 5	Q-SOL LAB-SY	White
NE	x	x	x		x		Polyolester	POE	ISO 22	EMKARATE RL 22HB	Yellow
						x	Alkylbenzene	AB	ISO 46	RENISO SP 46 V2	Blue
NT	x	x	x				Polyolester	POE	ISO 22	EMKARATE RL 22HB	Yellow
NJ	x	x			x		Polyolester	POE	ISO 22	EMKARATE RL 22HB	Yellow
						x	Alkylbenzene	AB	ISO 46	RENISO SP 46 V2	Blue

Only for exceptional cases, in accordance with the Embraco Technical support team or Sales team, the compressors can be shipped without oil.

7.11 MINIMUM QUANTITY OF LUBRICANT INSIDE THE COMPRESSOR

The oil charge of each compressor model is indicated in the **Embraco Product catalogue** on www.embraco.com

During the compressor running, oil is pumped out from the compressor. The system must be designed in order to carry the oil back to the compressor, (see Chapter **10.3.2**), however a certain amount of oil may remain inside the system.

The minimum quantity of oil inside the compressor that guarantees the correct lubrication is indicated in *Table 7.11*.

Table 7.11 Minimum quantity of lubricant

SERIES	EM	NE	NT	NJ
OIL CM³ MIN.	90	200	300	500

Data mentioned in above *Table 7.11* is valid for all the models (HFCs and HCs) of the same compressor series.

Oil quantities below the minimum prescribed level will not allow the oil pumping and will cause wear, leading to the eventual seizure of the mechanical parts.

System prototypes have to be checked for the oil remaining into the line tubes, condenser, evaporator and other parts after running in all the expected conditions that may happen in the field, assuring that the compressor contains in all conditions at least the quantity of oil indicated in the *Table 7.11*.

7.12 SPECIAL VERSIONS

Table 7.12 Special external version examples

SERIES	DESCRIPTION
EM/NE	Compressors with a bracket on the cover for the mounting of a water tray
NJ/NT	Compressors without suction tubes but with a fixture for Rotolock valve (valve not supplied)
	Compressors without suction tubes but with a fixture for Rotolock (supplied with unassembled valve and gasket)
	Compressors with oil equalization tube for Gemini version (see Chapter 10.3.8)
ALL SERIES	Compressors supplied without grommets and sleeves

8. COMPRESSOR PACKAGING

8.1 MULTIPLE PACKAGING

This type of package consists of a shipping skid of 835 mm x 1150 mm on which are positioned the elements composing the packaging of various compressor layers, as listed below, secured with straps to the shipping skid (see Figures 8.1.1.a - f).

Table 8.1.1 Pallet packages composition

A	SHIPPING SKID	on which the base is positioned
B	BASE	on which the first layer of compressors is positioned
C	SEPARATOR SKID	are positioned between layers, in quantities according to the compressor series
D	TOP SKID	upper element closing of the package

Figure 8.1.1.a "EM" (120 compressors)

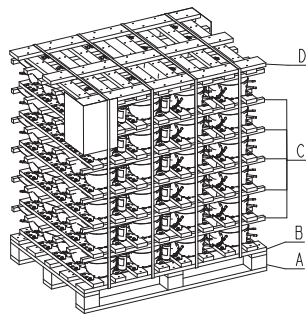

Figure 8.1.1.b "EM" (100/88 compressors)

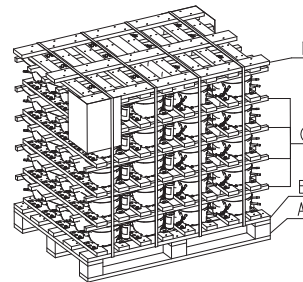

Figure 8.1.1.c "NE" (80/74 compressors)

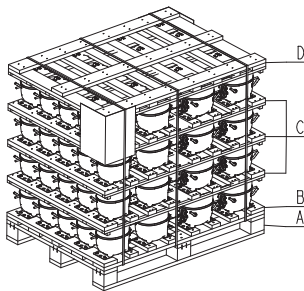

Figure 8.1.1.d "NE" (40/37/28 compressors)

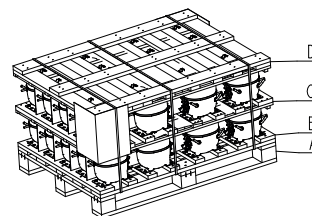

Figure 8.1.1.e "NT" (36/24 compressors)

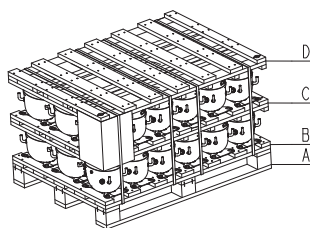

Figure 8.1.1.f "NJ" (36/28 compressors)

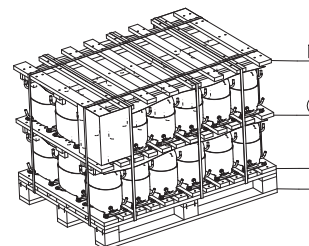

Table 8.1.2 Characteristics of multiple wooden packaging

SERIES	QUANTITY PER PALLET	CODE	PACKAGING TYPE	REFERENCE	ELECTRICAL COMPONENTS
EM	120	S	6 layers of 20 compressors	Figure 8.1.1.a	NOT ASSEMBLED
EM	100	V/G	5 layers of 20 compressors	Figure 8.1.1.b	ASSEMBLED
EM	100	R	5 layers of 20 compressors	Figure 8.1.1.b	NOT ASSEMBLED
EM	88	W	2 layers of 14 compressors; 3 layers of 20 compressors	Figure 8.1.1.b	ASSEMBLED
NE	80	M	4 layers of 20 compressors	Figure 8.1.1.c	NOT ASSEMBLED
NE	74	O	1 layer of 14 compressors; 3 layers of 20 compressors	Figure 8.1.1.c	ASSEMBLED
NE	40	N	2 layers of 20 compressors	Figure 8.1.1.d	NOT ASSEMBLED
NE	37	Q	1 layer of 17 compressors; 1 layer of 20 compressors	Figure 8.1.1.d	ASSEMBLED
NE	28	H	2 layers of 14 compressors	Figure 8.1.1.d	ASSEMBLED
NT	36	C	2 layers of 18 compressors	Figure 8.1.1.e	NOT ASSEMBLED
NT	24	Z	2 layers of 12 compressors	Figure 8.1.1.e	ASSEMBLED
NJ	36	C	2 layers of 18 compressors	Figure 8.1.1.f	NOT ASSEMBLED
NJ	28	Y	2 layers of 14 compressors	Figure 8.1.1.f	ASSEMBLED

8.2 SINGLE PACKAGING

This type of package consists of a carton box and an internal separator to prevent any compressor movement. The electrical components and accessories are included in the package (assembled or attached).

Complete pallet package consists of a shipping skid of 830 mm x 1130 mm on which are placed carton boxes with compressors secured with corner strip and straps (see *Figure 8.2.2*). Number of layers depends on compressor families, as indicated in the *Table 8.2*.

Figure 8.2.1 Carton box for single package

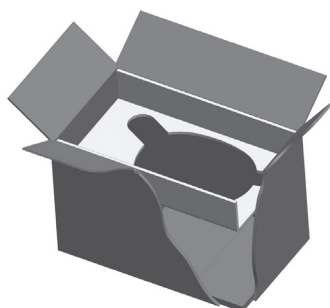

Figure 8.2.2 Single compressor pallet package

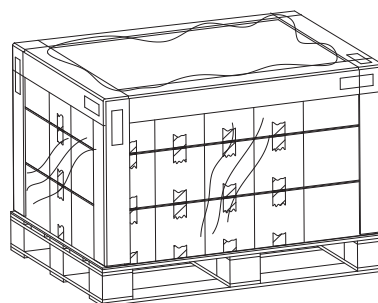

Table 8.2 Characteristics of complete single package

SERIES	QUANTITY PER PALLET	CODE	PACKAGING TYPE	ELECTRICAL COMPONENTS	NOTE
EM	70	A	5 layers of 14 compressors	ASSEMBLED	
EM	56	J	4 layers of 14 compressors	ASSEMBLED	
NE	56	A	4 layers of 14 compressors	NOT ASSEMBLED / ASSEMBLED	
NE	56	J	4 layers of 14 compressors	ASSEMBLED	
NE	44	F	4 layers of 11 compressors	NOT ASSEMBLED / ASSEMBLED	CSR electrical box included
NT	44	A	4 layers of 11 compressors	NOT ASSEMBLED / ASSEMBLED	
NT	44	F	4 layers of 11 compressors	NOT ASSEMBLED / ASSEMBLED	CSR electrical box included
NJ	33	A	3 layers of 11 compressors	NOT ASSEMBLED	
NJ	33	F	3 layers of 11 compressors	ASSEMBLED	CSR electrical box included

Wooden packaging and pallets are created to comply with recycling regulations and are treated according to standard ISPM No. 15 - Regulation of wood packaging material in international trade. IPPC mark is presented on the wooden palets.

8.3 PACKAGE FOR ELECTRICAL COMPONENTS AND ACCESSORIES

Electrical components and accessories if not assembled on compressors are packed separately in carton boxes. A label is applied showing the following data:

Components packing label

1. Components bill of material code
(complete of electrical components and accessories)
2. Compressor model
3. Quantity
4. Customer name (optional)
5. List of electrical components and accessories shipped
(code/description/quantity)

8.4 COMPRESSOR IDENTIFICATION MARKS

Labels are applied on two sides of each package and report the following data:

1. Compressor bill of material
2. Bar code of compressor bill of material (Type 39)
3. Compressor model
4. Voltage & frequency
5. Refrigerant
6. Package quantity (optional)
7. Packaging serial number
8. Bar code of packaging serial number (Type 128)

Figure 8.4.1 Compressor identification label for multiple packaging

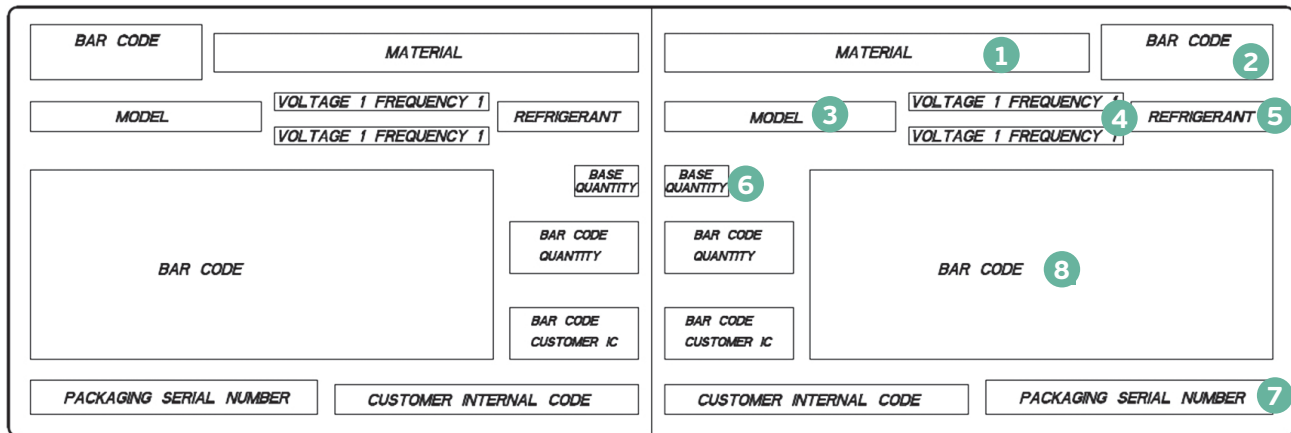
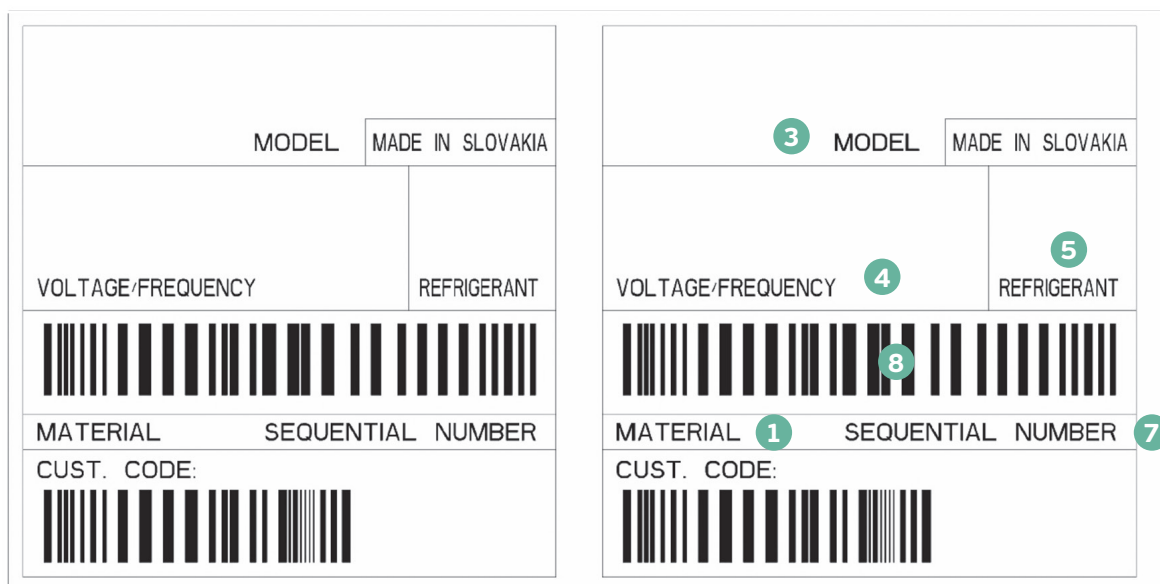

Figure 8.4.2 Compressor identification label for single packaging



9. HANDLING, TRANSPORTATION AND STORAGE

9.1 HANDLING



The handling of the multiple packages must be done only by forklift with due care, to avoid damages of the packages and compressors. Access is available from all four sides of the package. It is recommended the use of forks having a length adequate to the size of manipulated goods.

The multiple packages must not be handled with cranes by means of cables and hooks. Use of improper handling can result in person injuries.



Risk of pallets collapse and personal injuries, stacking higher than the recommended maximum, indicated in *Table 9.5.1* and *Table 9.5.2*, can cause accidents. Move pallets or single compressors only with appropriate mechanical or handling equipment according to the weight.

Keep the packages in the upright position. Keep the packaging dry at all times. Do not stack single boxes on top of each other.

For packages storage and moving refer to the Chapters **8** and **9**.

9.2 TRANSPORTATION

The transportation of all types of packaging must be made with the compressor in upright position. Acceptable compressor positions during transportation are indicated in *Table 9.3*.



Particular care is requested for the "Single packages", which are easier to damage. Incorrect transport can cause deformation of brackets and internal mufflers and /or oil entering into the suction mufflers and stator shifts, which can result in a reduction of stator/rotor air gap and reduction of bearings clearance.

The consequences during operation can appear with noise due to deformations of the internal mounting springs, and with starting problems of the electric motor.



Before to use compressors which are suspected of improper transport or damaged contact Embraco Technical support team.

9.2.1 SHIPMENT BY CONTAINER

The predominant method of transport is by container of which there are two different types for capacity and length: 20ft (about 6.1 m) and 40ft (about 12.2 m). The standard container used by Embraco is the 20ft, which allows in comparison to the 40ft, a higher ratio weight/volume and consequently a better utilization of the internal volume (the number of the compressors in a 40ft container is limited by the admitted total weight).

Table 9.2.1 indicates the characteristics of the load. For each compressor series are indicated: number of stocking pallet layer, number of compressors per each pallet layer and maximum total number of compressors.

Occasionally, some freight forwarders in the interest of expediency prefer to employ a 40ft container, even with the disadvantage of total volume utilization.

Table 9.2.1 Load characteristics for 20ft container

SERIES	FIRST LAYER (N° OF PALLETS - N° OF COMPRESSORS)	SECOND LAYER (N° OF PALLETS - N° OF COMPRESSORS)	THIRD LAYER (N° OF PALLETS - N° OF COMPRESSORS)	TOTAL N° OF COMPRESSORS MAX ⁽¹⁾
EM	14 - 120	14 - 80		2800
	14 - 100	14 - 100		2800
	14 - 88	14 - 88		2464
	14 - 70 ⁽²⁾	14 - 70 ⁽²⁾		1960
	14 - 56 ⁽²⁾	14 - 56 ⁽²⁾		1568
	14 - 80	14 - 80		2240
	14 - 74	14 - 74		2072
NE	14 - 40	14 - 40	14 - 40	1680
	14 - 37	14 - 37	14 - 37	1554
	14 - 28	14 - 28	14 - 28	1176
	14 - 56 ⁽²⁾	14 - 56 ⁽²⁾		1568
NT	14 - 44 ⁽²⁾	14 - 44 ⁽²⁾		1232
	14 - 36	14 - 36	14 - 36	1512
	14 - 24	14 - 24	14 - 24	1008
	14 - 36 ⁽²⁾	14 - 36 ⁽²⁾	⁽³⁾	1008
NJ	14 - 28	14 - 28		784
	14 - 33 ⁽²⁾	14 - 33 ⁽²⁾		924

(1) Different load structure – maximum quantity of compressors - is determined by the ratio between the maximum container weight and the compressor weight.

(2) Single packaging.

(3) Type of load which is rarely used. To be avoided due to an incomplete third layer.



Payload max 24 tons. Follow local limits.

Note: Above table is only indicative, taking to consideration one type of packaging and compressor family. For specific cases contact Embraco Customer care.

9.2.2 SHIPMENTS BY TRUCK

The transportation of compressors by truck is the most common system for highway or short distances where the stresses on the product are reduced. This type of transportation, if made without the necessary precautions on load steadiness and travel on uneven roads can cause stresses to compressors with possible damages to the suspension springs and to the internal discharge loop and muffler. For a 24,000 kg (11,000 lb) truck, the load composition is indicated in *Table 9.2.2*.

Table 9.2.2 Characteristics of load by truck

COMPRESSORY FAMILY	N° OF COMPRESSORS/PALLET	N° OF PALLET/TRUCK	N° OF COMPRESSORS/TRUCK
EM	120	21 ÷ 24	2520 ÷ 2880
	100	24 ÷ 28	2400 ÷ 2800
	88	28 ÷ 30	2464 ÷ 2640
NE	80	24 ÷ 26	1920 ÷ 2080
	74	24 ÷ 28	1776 ÷ 2072
	40	42 ÷ 46	1680 ÷ 1840
	37	48 ÷ 52	1776 ÷ 1924
	28	54 ÷ 58	1512 ÷ 1624
NT	36	28 ÷ 32	1008 ÷ 1152
	24	42 ÷ 46	1008 ÷ 1104
NJ	36	24 ÷ 28	864 ÷ 1008
	28	28 ÷ 32	784 ÷ 896

Note: Above table is only indicative, taking to consideration one type of packaging and compressor family. For specific cases contact Embraco Customer care.

9.3 ACCEPTABLE COMPRESSOR POSITIONS DURING TRANSPORTATION OF FINISHED PRODUCT

Table 9.3 represents the acceptable transportation positions. The positions marked with a cross are not allowed.

In particular cases the finished product may need to be transported in horizontal position (with the compressor in lying position).

Table 9.3 *Acceptable compressor position during transportation of finished product*

SERIES	NORMAL (UPRIGHT)	LABEL UP	TERMINAL BOARD UP	LABEL DOWN	TERMINAL BOARD DOWN	UPSIDE-DOWN
EM						
NE						
NT						
NJ						



In case the cabinet is transported with compressor in lying position, before to start the cabinet after having up righted it, wait at least 15 minutes allowing the oil, eventually entered in the suction muffler, to drop out.



In case the compressors are lying during the assembly of the finished products, oil will enter in the suction/service tubes causing problematic brazing of the line tubes and hazardous fumes.

9.4 ACCELERATION DURING TRANSPORT AND HANDLING



Maximum allowable rate of deceleration/acceleration: 1g

Generally we advise against the rail transportation because during the shunting, stress to the compressors from decelerations or acceleration can cause stator shifts, or deformation or breaking of internal discharge tubes and brackets.

For conditional approval of specific cases please contact Embraco Logistics or Technical support team.

9.5 COMPRESSOR STORAGE



Failure to follow these instructions can result in property damages and people injuries. For the solution of potential positioning problems during assembling and transport, consult the Embraco Technical support team.



The storage of palets can be done by placing one package upon another according to the limits indicated in *Table 9.5.1* and *Table 9.5.2*.

Table 9.5.1 Compressor multiple package storage - maximum height

NE – 28/37/40 COMPRESSORS NT – 24/36 COMPRESSORS NJ – 28/36 COMPRESSORS MAX 5 UNITS	EM-NE 74/80 COMPRESSORS MAX 3 UNITS	EM 120 COMPRESSORS MAX 2 UNITS	EM 88/100 COMPRESSORS MAX 2 ^(*) UNITS

(*) Note: in case of need to stack 3 units, contact Embraco Technical support team.

Table 9.5.2 Compressor single package storage - maximum height

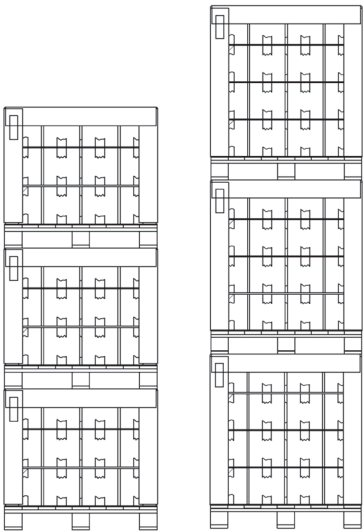
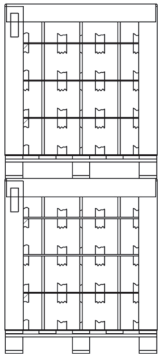
EM - NE - 44 COMPRESSORS NT - 44 COMPRESSORS NJ - 33 COMPRESSORS MAX 3 UNITS	EM - 70/56 COMPRESSORS NE - 56 COMPRESSORS MAX 2 UNITS
	

All packages must be stored in places protected from humidity and bad weather as indicated in Chapter 9.6.

Embraco does not take any responsibility for occasional damages to the package and to the finished product resulting from not observing these instructions.

For the solution of potential positioning problems during assembling and transport, consult the Embraco Technical support team.

9.6 STORAGE CONDITIONS



Compressors and electrical components should be stored in closed ambient, protected against rain, water drops, dust and contaminants; air humidity should not exceed 80 %. Salty sea ambient (transport by vessel, load, unload) are admitted only for the periods of transportation and custom clearance; storage on the sea board should be avoided.

Storage ambient temperature: min -25°C / max 55°C; for limited periods (like transportation in containers in tropical areas) temperature up to 70°C are admitted.

In the case of storage at low temperatures, before the compressor is installed into the refrigeration system, they must be stabilized at higher temperatures until the compressors are at +5 °C minimum. The same must be applied to finished products stored at low temperatures before to start the compressor.

Even if properly stored, after prolonged storage period (over 5 years) the oil on the cinematic parts of the compressor may dry, making the first start of the compressor difficult and the tube plugs may deteriorate allowing air/humidity enter into the compressors.

In case of longer storage time, before using the compressors contact the Embraco Technical support team.

10. RECOMMENDATIONS ABOUT CORRECT COMPRESSOR INSTALLATION

A functional and efficient refrigeration system is the combination of various components, properly selected and assembled in order to reach the pursued safety level and performance of the finished product and respecting the admitted limits of each component. The compressor is one of the system components: the information of this Installation Instructions relates only to the Embraco compressors with their standard electrical components and accessories.



For the compressor connection to the electrical supply line and for maintenance/repairing operations, refer also to Appendix 1- Recommendations - safety instruction for compressor installation.



Correct position of compressor when installed into the system is upright/vertical with inclination tolerance of max 3°.

10.1 COMPRESSOR SELECTION

10.1.1 CHARACTERISTICS OF THE HERMETIC COMPRESSOR

The hermetic compressors are very specialized machines, designed:

- a) To work with a specific refrigerant
- b) For a specific type of application (LBP or MBP or L/MBP or HBP or ULBP)
- c) With LST or HST electrical motor
- d) For electrical supply at 50 or 60 HZ with a certain supply voltage
- e) To deliver a certain cooling capacity
- f) To be properly cooled
- g) To operate in certain admitted working range
- h) To be properly installed

10.1.2 SELECTING THE PROPER COMPRESSOR



Correct function of defined compressor and related electrical accessories is possible only if requirements mentioned in points a) ...h) are assured. Working out of the defined limits may result in malfunction of the compressor caused damages to properties and injuries to persons.

The information corresponding to a), b), c), d), e) are indicated in the compressor label and compressor name code (compressor model printed on the label contains in his code the rated cooling capacity see Chapter 5.2).

The compressor cooling capacities at various evaporating temperatures, with condensing temperatures as parameter are indicated in the Technical datasheets in the **Embraco Product catalogue** on www.embraco.com

The admitted voltage limits and admitted working ranges are indicated in *Table 4.4* and *Table 11.6.1*.

10.1.3 RECOMMENDED GUIDELINE FOR THE COMPRESSOR SELECTION

10.1.3.1 MINIMUM / MAXIMUM EVAPORATING TEMPERATURE

The minimum / maximum evaporating temperature of the system allows the identification of the compressor application LBP or MBP or L/MBP or HBP or ULBP (see *Table 4.1*).

10.1.3.2 APPROPRIATE COOLING CAPACITY

The compressor model with adequate cooling capacity can be identified by referring to the **Embraco Product catalogue** on www.embraco.com

10.1.3.3 REFRIGERANT TYPE

The refrigerant type admitted for each compressor model is indicated in **Embraco Product catalogue** on www.embraco.com and on the compressor label.



For each compressor use only the refrigerant indicated in the **Embraco Product catalogue** on www.embraco.com and on the compressor label. Usage of different refrigerants can generate abnormal working conditions, excessive pressure in the refrigeration system, damages of the compressor and explosions.

10.1.3.4 ELECTRIC MOTOR STARTING TORQUE

The selection of the electric motor starting torque type (LST - low starting torque; HST - high starting torque) must be made according to the suction and discharge pressures of the system at the compressor start. The motor starting torque type (LST or HST) is indicated in the **Embraco Product catalogue** on www.embraco.com and on the name code (see Chapter 5.2).

For systems with capillary tubes or expansion valves with pressure equalization at the compressor start, a low starting torque (LST) is suitable (tests must be carried out on the cabinet at the normal and abnormal expected conditions to verify the actual pressure equalization before each compressor start).

For systems with expansion valve or capillary tube where the suction and discharge pressures remain unbalanced at the compressor start, it is necessary to use a high starting torque compressor (HST).

See the admitted starting limits in the *Table 11.6.2*.

10.1.3.5 SUPPLY VOLTAGES AND FREQUENCIES

The compressor must be selected according to the voltage and frequency conditions where the cabinet will operate in the field.



Verify that the voltage fluctuations are within the admitted limits of the selected compressor (see *Table 4.4*). Voltage must be measured at the compressor electrical pins at the start and running at the max load conditions, see the safety advice at Chapter **10.10.1**.



Deviations of the supply voltage from the approved limits may impact the overload protector actuation and damage the compressor and other parts. See Chapter **10.1.6**.

10.1.3.6 AMBIENT TEMPERATURE

The ambient temperature surrounding the system strongly influences the compressor working conditions. The system must be designed and tested in order to ensure that the compressor works (at normal and abnormal expected conditions in the field) within its admitted limits (see Chapter **11.6**) at the max ambient temperature where the system will be installed.



Compressors are intended for indoor use. External use can be accepted only when installed on cabinets specifically designed for this type of use. See the admitted starting limits in the *Table 11.6.2*.



An ambient temperature higher than 5°C is required for proper compressor starting and working, in order to have a correct lubrication. If ambient temperature is around the above value or lower and refrigerant charge is approaching or overcoming the maximum allowed limit, the use of a crankcase heater is required (see Chapter **10.3.4**).



Deviations from the admitted working limits of the compressor may damage it or shorten its life time.

10.1.3.7 COMPRESSOR COOLING TYPE

The cooling type (static and/or fan cooling) of each compressor model is indicated in the **Embraco Product catalogue** on www.embraco.com

- **Static cooling:** compressor does not require forced ventilation cooling and natural air circulation can adequately cool the compressors to avoid overheating
- **Fan cooling:** compressor requires the use of a fan cooler (normally inlet type) positioned in such a way that the air flows to the compressor sideways, see *Figure 10.1.3.7*
- **Static and Fan Cooling:** compressor is approved to be used either with forced air ventilation or natural air circulation



The compressor overload protector may not trip, and may not protect the compressor properly in case the air flows directly on it (see Chapter **10.1.6**).

The fan cooler shall provide an air flow indicated in *Table 10.1.3.7* and be installed according to the *Figure 10.1.3.7*.



Deviations from the recommended fan position may overheat the compressors; in certain cases may impact the overload protector actuations and damage the compressor and other parts. See Chapter **10.1.6**.

Table 10.1.3.7 Fan cooler characteristics

COMPRESSOR SERIES	EM* - NE - NT	NJ
Free Air Flow (m ³ /h)	520	800

*For some EM models the air flow is 270 m³/h. For detailed information, check **Embraco Product catalogue** on www.embraco.com

Figure 10.1.3.7 Fan motor positioning

Fan motor should be placed at 30 cm \pm 1 cm from the compressor with air flow oriented to the lateral side of the compressor according to the picture below:

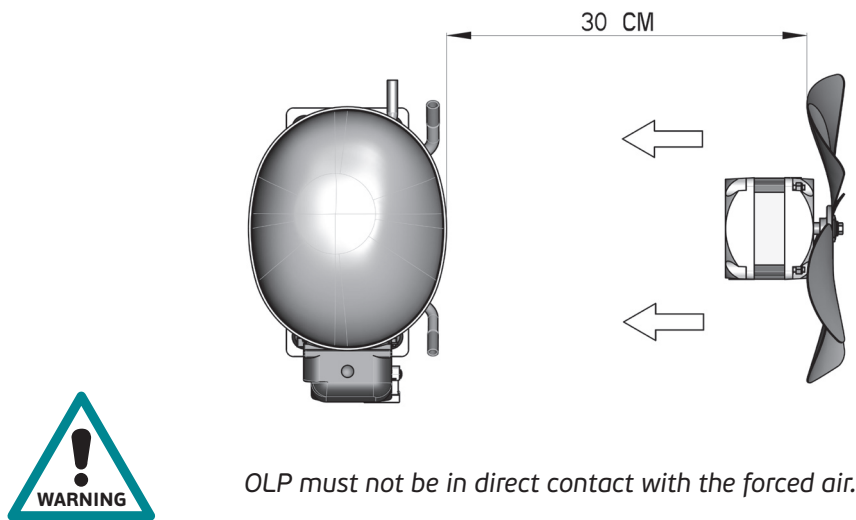

10.1.4 NOISE AND VIBRATIONS

The Embraco compressors are characterized by low noise emission, low vibration and pulsation; furthermore the internal mounting spring and discharge loop are designed in order to reduce the transmission of the starting/stop torque reaction to the mounting base and to the line tubes.

Embraco supplies mounting grommets (see Chapter **10.8**) that further reduce the transmission of vibration and reaction torque to the fixing points and tube of the system. Base plate of the cabinet must have sufficient mass and stiffness to further reduce transmission of residual vibrations.

Line tubes must be designed to support stresses without be damaged and to reduce transmission of vibrations to the cabinet structure and should be sufficiently flexible on the 3 axis.

Vibration/pulsation/resonances

Gas pulsation depends on gas flow rate and pressure conditions: each refrigeration system, due to the specific cabinet structure, tube design and layout, has its own reaction to the:

- Gas pulsations in the discharge line.
- Torque/vibrations acting on the compressor mountings.
- Torque/vibrations acting on the suction and discharge tubes connections and pipes.
- Possible resonances (with suction and discharge lines, compressor base plate and other structural elements) generated by the compressor and fan motor(s) running.

All the above elements must be considered in the system design in order to avoid abnormal noise and component breakages; the system should be checked at its normal and expected worse working conditions (starting, running, Hot Gas Defrost, high load, max ambient temperature, low voltage supply, etc): in case abnormal pulsations are detected, measures must be taken to avoid them (contact Embraco Technical support team).

Eventually a discharge muffler or a dumper on the system tubes can be adopted: contact Embraco Technical support team for support.



Mechanical resonances can lead to breakages of tubes and structural parts due to fatigue or to other resonance problems: this issue is particular critic when using HCs refrigerants. Regulations like EN 378 and similar require resonance tests on the system components.

Check carefully the entire application for abnormal vibrations/resonances at all possible working conditions and adopt measure to eliminate them, contact Embraco Technical support team for assistance and corrective actions.

10.1.5 MAXIMUM CONTINUOUS CURRENT (MCC)

The compressor does not have a fixed max input current value (it can be defined making reference to the requirements of certain safety institutes, like UL).

10.1.6 OVERLOAD PROTECTOR (OLP)

The compressors are protected against overheating by the overload protector. It can be external (fixed on the compressor shell), or internal (mounted on the motor head, or on the internal pins of hermetic terminal).

The OLP detects unusual motor temperature rise and/or abnormal high current input. The OLP trip is influenced by several factors - working conditions, suction gas density/ temperature, supply voltage, etc.



In certain cases (described below), the overload protector (OLP) may not function as intended:

- Loss of refrigerant charge.
- System working outside the admitted working limits (Chapter 11.6.1), mainly with too low evaporating pressure and high condensing pressure.
- Voltage over the admitted limit (see *Table 4.4*), mainly with low load.
- Fails to start (e.g. Due to a supply voltage too low or abnormal pressure) with cold compressor: in this case the thermal inertia of the olp cannot follow the motor temperature gradient (normally of the start wiring) and the motor or starting capacitor may burn-out.
- Electrical motor stall (e.g. Due to abnormal pressure or low voltage) especially after the starting: in this case the starting relay will switch on/off repeatedly, overheating the electrical motor and/or the starting capacitor before the olp has the possibility to detect the temperature rise.
- Improper air flow on the overload protector by the cooling fan improper installed (see *Table 10.1.3.7* and *Figure 10.1.3.7*).
- Usage of motor fan on a compressor approved for static cooling operations.

10.1.7 ELECTRICAL SUPPLY LINE AND CABINET SUPPLY CABLE



The electrical supply line of the finished product must be protected against over-current, short-circuit, short-to ground. A Residual-Current Circuit Breaker (RCCB) must be adopted. Design, components and installation must comply with the applicable National and International Standards and regulations. The compressor must be properly connected to ground.



The cables of the cabinet and of the compressor must be designed for temperature, due to ampere load, and for voltage drop (see *Table 4.4*) taking into consideration the max input current of the finished product and the compressor LRA (Locked Rotor Amp), indicated for each model in the **Embraco Product catalogue** on www.embraco.com

In any case, the supply cable, as well as all other cabinet cables, must be designed and protected in order to comply with the applicable International standards and regulation, as well the National Standards and regulations of the country where the system will operate.



For the compressor connection to the electrical supply line and for maintenance/repairing operation, refer also to Appendix 1 - Recommendations - safety instruction for compressor installation.

10.2 COMPRESSOR UNPACKING



Remove the compressor from the package keeping it in upright position. Failure to maintain the compressor in an upright position can result oil entering into the suction and process tubes, with consequent brazing problems. Oil may also enter inside the suction muffler and when the compressor start after the refrigerant charge the compressor suction/discharge valve may be damaged.

For the same reasons, the compressor must remain upright while assembling the grommets and sleeves (see Chapter **10.8**) to the cabinet base plate.

10.3 SYSTEM COMPONENTS

The proper selection of components, the adherence to the applicable regulations and standards, the adoption of correct design criteria and complete set of tests of the prototypes, accurate production processes and quality control allow the manufactures to produce reliable and safe refrigeration systems.

Because of the vast differences between refrigeration systems and the various working conditions typical of each application, the reliability of the equipment should be validated by appropriate life and field tests before to launch the mass production.

All the above tests shall confirm that the compressors are used - under the most severe conditions expected to occur in the field - within their admitted working range (see *Table 11.6.1*).

10.3.1 HUMIDITY AND CONTAMINANTS

Embraco adopts consistent production and quality processes in order to keep the contaminants (solids particles and not condensable residuals) and the internal humidity of the compressors within the strict admitted limits. Furthermore, in all production processes of Embraco external suppliers, all substances non-compatible with the refrigerant to be used and with the oils charged in the compressors have been eliminated. These included all chlorine based compounds.

Cleanness and reduced humidity level in all the components of the refrigeration system are the primary concerns for the compressor good running and life



Embraco recommends the use of system components (tubes, condensers, evaporators, oil separators, liquid receivers, valves, capillaries, etc.) having humidity, soluble, insoluble, solid residuals as written below; and free of Chlorine based compound (and free of no ester based oils for the compressor using Polyolester oil - POE) and in accordance with the standards like EN 12735 (Copper and copper alloys).

Soluble and insoluble residuals which are ascertained by washing with solvents may not exceed 100 mg/m² of the entire inner volume. Of this, a maximum of 40 mg/m² of soluble and 60 mg/m² of insoluble is permitted. Parts which inner surface is lower than 0,2 m², follow **Table 10.3.1a**.

The practical size of residuals to be below the following values:

- For flitters: thickness < 10µm, size ≤ 0,5mm
- For particles: size ≤ 0,1mm

Table 10.3.1a Soluble and insoluble residual limits

INNER SIZE M ²	SUME OF SOLUBLE AND INSOLUBLE RESIDUALS (mg)
≤ 0,1	15
0,1 – 0,15	20
0,15 – 0,2	25

Humidity limits for components of circuite may not exceed 50 mg of water per m² of inner surface. Parts which inner surface is lower than 0,2 m², follow **Table 10.3.1b**.

Table 10.3.1b Humidity limits

INNER SURFACE M ²	PERMISSIBLE HUMIDITY (mg)
≤ 0,1	≤ 5
0,1 – 0,15	≤ 12
0,15 – 0,2	≤ 14

Note: Above mentioned limits are extracted from standard DIN8964, which was withdrawn, though it is the only one standard related to this topic. Embraco recommendation is to allow max 50% of this specification.



Presence of solid or soluble conductive elements may result in damage of insulation system of motor-compressor. In the worst case failure of hermetic terminal insulation may happen and consequent leak of refrigerant is possible.

Special care shall be taken for removal of any cleaning residua after condenser or evaporator cleaning process. Any solution which contains sodium, potassium or similar may result in serious damage of motor-compressor (creation of conductive path on hermetic terminal glass insulation).

10.3.2 PIPING BASIC PRINCIPLES

The entire refrigeration system must ensure that the compressor work within the admitted limits indicated in the Chapter **11.6.1**.

The design and layout of refrigerant piping system and components should:

- Avoid excessive pressure drops (that reduce the energy efficiency and may overheat the compressor).
- Ensure the lubricant oil returning to the compressor, preventing oil traps in any part of the system at the minimum load conditions.
- Avoid liquid refrigerant or oil slugs entering into the compressor during starting and operating.
- Minimize the refrigerant charge.

10.3.2a EVAPORATOR AND CONDENSER

Their design and layout depend on the system types and characteristics.

10.3.2b LIQUID LINES - VALID ALSO FOR CLOSE COUPLED REMOTE SYSTEMS

Max length 10 m. For longer length contact Embraco Technical support team.

Pressure drop should be low in order to avoid gas formation in the liquid line and/or insufficient liquid pressure at the expansion device. As reference, the pressure drop due to friction in the liquid line should be not greater than that corresponding to about a 0.5 to 1 K change in saturation temperature.

Liquid subcooling is necessary to get liquid at the expansion device (with HCs the subcooling should be minimized in order to reduce the refrigerant charge). With insufficient subcooling the refrigerant will flash in the liquid line reducing the feeding of the evaporator, with drop of performance and efficiency.

The friction pressure drops caused by accessories - such as solenoid valves, filter driers - and the losses equivalent of line risers should be accounted for in order to define the proper liquid line subcooling.

In case the line tube passes in hot ambient (with transmission of heat to the tube) its insulation may be necessary.

10.3.2c SUCTION LINES - VALID ALSO FOR CLOSE COUPLED REMOTE SYSTEMS

Max length 10 m, with suction line upright max 3 m. For longer length contact Embraco Technical support team.

Suction lines should be designed to generate a minimum pressure drop at full load as well as ensure the oil returning to the compressor under minimum load conditions.

Pressure drop in the suction line forces the compressor to work at lower pressure than the ones required by the evaporator, reducing cooling capacity and efficiency,

As reference the suction line is normally sized to have a pressure drop from friction, lower than the equivalent of 1 K change in saturation temperature.



Excessive pressure drops in the high pressure side and low pressure side reduce the energy efficiency of the system and force the compressor to work at higher compressor ratio with higher mechanical stresses

The horizontal suction line should have an inclination of at least 3 % toward the compressor.



Suction line design criteria must ensure oil returning to the compressors when the system is working at minimum (normal or abnormal) load. This will generate higher pressure drop at full/maximum load.

In certain systems, the suction lines should be insulated to ensure cool suction gas to the compressor. Cold gas is necessary in order to help cooling the motor windings of the static cooled compressors, as well as the fan cooled ones (even if properly ventilated by the fan).

In any case the insulation should not cause liquid return to the compressor.



For compressor admitted working range see Chapter **11.6.1**.

At any working conditions, avoid excessive suction gas overheating, as well as the return of liquid refrigerant to the compressor.



Suction lines insulation will help to prevent sweating. In any case the suction line must be positioned away from the compressor terminal board (and other electrical devices) to avoid electrical short circuits, grounds and rusting/corrosions caused by spills of condensed water droplets.

For the same reason, tubes discharging the water from defrost must not lie above the compressor terminal board, in order to avoid drops of condensation water on it.

10.3.3 EXPANSION DEVICES

10.3.3a CAPILLARY

For preparing a prototype of a new refrigeration system, refer to the capillary tube selection tables (Chapter **10.7**) as a first reference. For each system, the optimal dimensioning of the capillary tube should be determined by appropriate tests in the application labs, in order to optimize the working conditions, performance and energy consumption.



It is not recommended to use a capillary tube with an internal diameter less than 0.6 mm

10.3.3b THERMOSTATIC EXPANSION VALVE (TXV)

Proper TXV size is determined by the refrigeration load requirement, the pressure drop across the TXV, and the evaporator temperature.



TXV must be sized and set in order to get the appropriate superheat, avoiding "hunting" (*) in the evaporator and liquid back to the compressor.

For accurate sizing and installation the instructions the TXV manufacturer should be consulted.

(*) *Hunting of TXVs is the alternate excessive-reduced flow of the refrigerant injected in the evaporator, with possible liquid return to the compressor.*

10.3.4 USE OF LIQUID SEPARATOR AND CRANKCASE HEATER



In case the refrigerant charge exceed the max admitted by Embraco compressor (see *Table 10.6.1.5*) a liquid receiver with proper size should be installed on the system suction line. A compressor crankcase heater should also be installed, to avoid mixing of liquid/oil entering into the cylinder at the compressor start after prolonged stops.

At the lowest ambient temperature foreseen for the application, the crankcase heater should maintain the oil temperature at least 15 K higher than the saturation temperature of the low pressure side.

In case of cabinets working in low ambient temperature, the compressor should be equipped with a crankcase heater to keep the compressor temperature over + 5°C.

The crankcase heater need an independent electrical supply line: it should be energized sufficiently in advance (4-6 hours may be required) in case the compressor has to start after long stop.

During normal on-off compressor cycle, the crankcase heater should be switched off. If the compressor has long off cycles, the crankcase heater should be switched on after 20-30 minutes after compressor stops.

During prolonged off cycles the refrigerant migrates to the component having the lowest temperature and an accumulation of liquid refrigerant may occur inside the compressor crankcase, with refrigerant/oil mixture.

If the compressor starts in this condition and the system has a refrigerant charge higher than the maximum value allowed (see *Table 10.6.1.5*), the diluted oil cannot properly lubricate the cinematic parts causing accelerated wear or seizure.

Furthermore the sudden pressure drop inside the compressor after the starting will generate a “flashing” of the refrigerant with oil foam and consequent abnormal oil pumping out of the compressor, valve damages and cylinder head gasket blow can occur.

10.3.5 LEAK CONTROL



It is recommended special attention to the correct brazing of the system components to avoid the possibility of refrigerant leaks.

To check for leakages, use leak detector suitable for the specific refrigerant, with a sensitivity of less than 3 g/year.

10.3.6 HIGH PRESSURE CONTROL

To protect the system from discharge overpressure and damages to the compressor as well as safety risks, it may be necessary to install a high pressure limit switch (pressostat), according to the refrigeration system design and the applicable International and national regulations, to control the maximum discharge pressure. The settings on this switch should be in accordance with the limits established in *Table 11.4* and the reset after switch-off should be manual



Do not use the compressor to pressurize the system for controlling the pressostat set-point.

10.3.7 COMPRESSORS WITH INTERNAL PRESSURE RELIEF VALVE (IPR)

In order to prevent abnormal pressure at the cylinder head, (that may be generated by condenser fan block, or dirtiness on the condenser), the NT compressor series has models equipped with an IPR. These models are indicated with the suffix “V” in their denomination code. For the available models see the **Embraco Product catalogue** on www.embraco.com

Note: *The IPR also prevents damages to the valves/gaskets in case of overpressure due to flooded start consequent to a migration of refrigerant inside the compressor during the compressor stops (in any case this situation must be avoided and if the refrigerant charge exceed the max admitted limit, the preventive actions said at Chapter 10.3.4 must be adopted).*

On certain applications the IPR may contribute to comply with the requirements of the fan block test as requested by some safety standards.

If the overpressure (difference between discharge and suction pressure), is beyond the preset limit, the IPR discharge the refrigerant from the high pressure side to the low pressure side, in the inside of the compressor shell (it does not relief pressure (refrigerant) outside the system).

The IPR, once opened may remain active until the compressor will stop by OLP trip, and the pressures are equalized.



In case the IPR appears to have a leakage, stop the compressor and wait for the pressure to equalize. Repeat 3 times this operation and if the leakage persists replace the compressor.

10.3.8 EMBRACO COMPRESSORS WITH OIL EQUALIZATION TUBE FOR GEMINI (TWIN)

The NT and NJ compressors have versions with a tube connection for parallel applications (contact Embraco Sales for details on the available models).

The use of parallel compressors may present some advantages vs. two compressors working on independent circuits (i.e. cost reduction by using a single larger TXV) or vs. a single larger compressor with equivalent cooling capacity (energy saving by operating the on-off in sequence and reaching a part load efficiency similar to the full load one; low starting current when the compressor start successively).

However it requires an accurate system design, which validity should be confirmed by a complete set of tests (*), in order to verify that the parallel system ensures the essential requisites for a reliable application:

- The oil return to both the compressors
- The operation of the compressors within their admitted limits

(*) *Suggested tests should include (but not limited to): cabinet rated conditions, starting, defrost (if applicable), high load, low load and running at the more severe conditions (normal and abnormal) expected in the field.*

In addition to the Chapters **10.1** up to **10.3.7**, the following points shall be considered:

Number of parallel compressors: Embraco suggests to use parallel system with 2 Gemini compressors. For systems with more parallel compressors contact Embraco Technical support team for instructions.

Supply conditions: the Gemini compressors are only supplied as single compressor provided with the connection port for parallel application, see **Figure 10.3.8.1**.

Figure 10.3.8.1 Gemini compressor with connection port

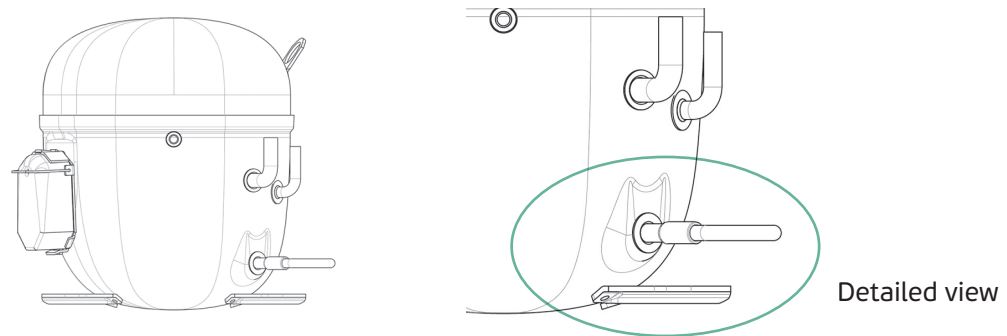

Compressor mounting: the compressors must be mounted on the same base plate in horizontal position and at the same height in order to assure the proper oil level in both the compressors, see *Figure 10.3.8.2*.

Oil equalizer tube: its OD shall be the equivalent to the ID of the compressor oil equalizer tube and lean horizontally. It must have sufficient 3 axis flexibility; in this case the compressors can be assembled independently on their rubber grommet. If the oil equalizer tube is rigid, it's necessary that also the compressors are connected rigidly, by screwing them directly on the base plate or rails. The base plate must lean on rubber grommets, the same used for the NJ or NT compressors, see specification in *Figure 10.8. 2*. When is necessary to use a long oil equalizer tube (> 0.4 m) add to the system a quantity of oil equivalent to the internal volume of the tube (for the oil type see the **Embraco Product catalogue** on www.embraco.com)

Suction lines: the entering of the compressor must be interconnected in order to ensure a balanced pressure drop and an equal distribution of the oil to the two compressors. Small differences may generate critical oil level differences, see *Figure 10.3.8.2*.

System piping connections: should be designed with sufficient three-dimension flexibility.

Condenser fans: use a multifan condenser, with a fan motor for each compressor. Each fan motor and compressor should start together.

Check valve: use check valve on discharge lines to avoid condensation of the refrigerant inside the compressor head during off-cycle.



The high pressure safety switch: shall stop both compressors. Eventual pump down switch should be set slightly higher than the low side safety pressure switch; also this last one shall stop both the compressors.

TXV: in case of using a single evaporator systems the selection of the TXV needs to consider both the max and min load (if the cooling capacity is controlled by step-running of the compressors). It should be selected slightly lower than the max load in order to ensure a min of 5 K superheat at min load. Care for avoiding "hunting" when the system is working at min load. (see Chapter **10.3.3b**).

The refrigerant charge: should be sufficient to avoid flashing before the TXV at max load. If refrigerant charge exceeds the double of the max refrigerant charge allowed for each compressor (see Chapter 10.6.1.5), adopt the preventive measures indicated in Chapter 10.3.4.

Compressor start with delayed starting of one compressor:

- a) initial start after prolonged off period; the first compressor shall start at balanced pressure within the limit of *Table 11.6.2*; the second ones at unbalanced pressures taking care that the suction pressure (its corresponding temperature) is below the value of the *Table 11.6.2* for the unbalanced starting.
- b) normal on/off cycling or after defrost; the compressors shall start with unbalanced pressure according to the *Table 11.6.2*.

Gemini compressors have admitted working range as the standard ones, indicated in *Figure 11.6.1*.

Figure 10.3.8.2 Compressor mounting and oil level indication

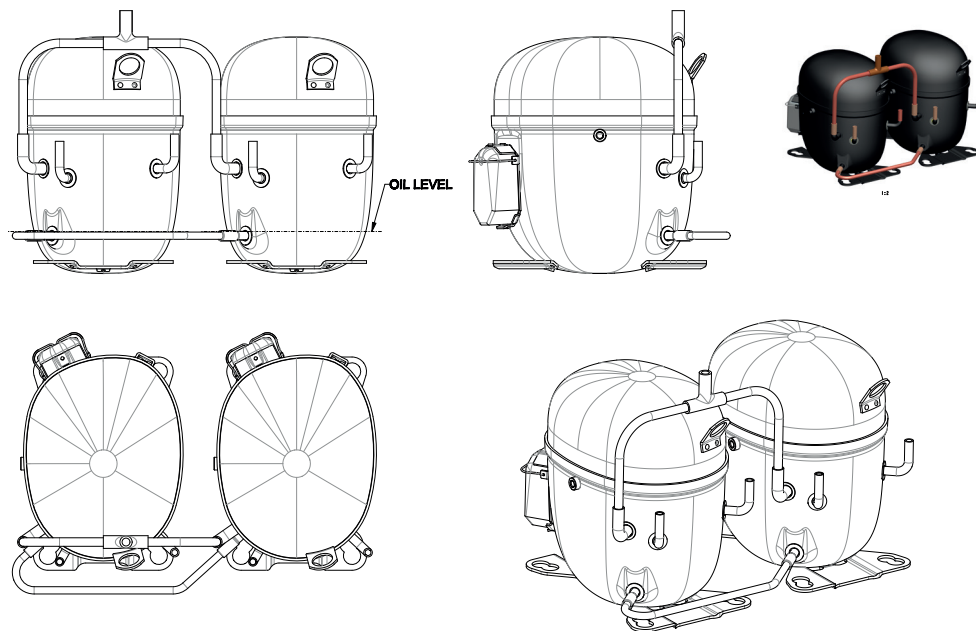

10.4 LIQUID LINE FILTER DRYER

The filter-drier type to be adopted depends on the refrigerant used in the system. The adsorbing capacity of the dryer should be selected according to the system internal volume, refrigerant charge and system initial humidity content.

Table 10.4a Suggested filter dryer molecular sieves: 3 or 4 Angstrom

REFRIGERANT	MOLECULAR SIEVE
R134a	XH - 7 - 9 - 11
R600a - R290	XH - 5 - 6 - 7
R404A - R507A - R407C	XH - 9 - 11



Filter-dryer manufacturers offer a list of drier types and models, depending on the application: always consult the manufacturer for the proper selection of a filter dryer.

Note: Polyolesters have high miscibility with HFCs and HCs refrigerants and high lubrication/temperature characteristics; however they differ from mineral oils or AB oils in some basic aspects:

- They are highly hygroscopic, adsorbing humidity much more rapidly than mineral oils.
- They have “polar” structure, meaning that dirtiness and wear materials will remain in suspension and circulate throughout the refrigeration system.
- They may hydrolyze in the presence of water generating acids.

A filter-drier for refrigeration systems with polyolesters has to positively face these characteristics.

Considering the effect of residual humidity (see **Table 10.4b**) in the refrigeration system, the drier used on compressors with POE should have excellent humidity adsorption and should be sized with capacity 15-20 % bigger than the filter-dryers used in mineral oil systems.



The filter dryer must be properly protected from adsorption of ambient humidity during assembly of the system according to the following practices:

- The dryers should be assembled on the system and brazed immediately after opening of the dryer’s plugs
- The filters supplied without protection caps, in “blister” or in “hermetic boxes” must be duly protected to avoid humidity adsorption before brazing.



The level of humidity present in the refrigeration circuit with the refrigerant charge should be below 40 ppm. After the system has been operating, the filter dryer should remove humidity in order to ensure a level below 20 ppm.

A reduced adsorption capacity of the dryer can cause an incomplete water adsorption by the molecular sieve. Therefore, the humidity could circulate freely in the system with the effects indicated in **Table 10.4b**.

Table 10.4b Problems caused by humidity in the system

ICE BUILD-UP	Reduces the cross-sectional area of the capillary tube, or expansion valve, up to their complete obstruction.
HUMIDITY CIRCULATION	Causes serious problems in the compressor and to the molecular sieve of the dryer. Typical marks and consequences are: <ul style="list-style-type: none"> • Copper plating of valve plate, valve reeds, crankshaft bearings, etc. • Etching of electric motor insulation by acids, with burning of motor windings • Disintegration of molecular sieve and build-up of "dusts" • Wears and blocks alternative and rotating mechanical parts
OIL HYDROLYSIS	Causes acidification (evidences by change of oil color - brown). It will cause build-up of sludge, with subsequent poor lubrication of compressor.



To prevent desiccant grains from abrasion, ensure liquid refrigerant at the inlet of the expansion device and a rapid pressure balance in case capillaries are used. The dryer should be installed in vertical position, with refrigerant inlet from the top.

10.5 BRAZING PROCESS

Welders must be trained and qualified technicians and all applicable safety regulations and procedures must be adopted



Do not allow the flame from the torch to reach the housing during the brazing of the compressor tube in order to avoid overheating, damages to brazing of housing-tubes, and oil carbonization on the compressor's internal shell wall.

Do not allow the flame from the torch to approach the "hermetic terminal (fusite)" in order to avoid the cracking of the glass insulating material of the pins and subsequent gas leaks (see possible consequences on Chapter 6.1.1).



To minimize any entry of contaminants and humidity, the compressor should remain open no more than 15 minutes between the extraction of the tube rubber plugs and the system tubes brazing.

Also the system components should remain sealed as long as possible before their assembly. The brazing of the components to the system should be carried out no later than 15 minutes after their assembling.

We suggest removing the rubber plugs from the tubes of the compressor (keep it in upright position) in the following sequence: discharge tube, suction tube and service tube.

A different sequence can cause oil being carried out of the compressor by the internal pressurization with subsequent brazing difficulties on the tubes and internal contamination due to oil residues.

The internal oiling of the tubes can generate dangerous smoke when brazing, make the brazing difficult, and introduce contaminants into the system due to "oil cracking".



To avoid compressor breakdown, capillary or expansion valve orifice plug, blow oxygen-free-dry-nitrogen (OFDN) at very low pressure through the system during brazing. OFDN removes the air and prevents the formation of copper oxides in the brazed parts. that later can be dragged throught the system and block the above components.

10.6 REFRIGERANT USE GUIDE

Embraco compressor range includes models for HFCs R134a, R404A/R507A, R407C and HCs R600a, R290, see details in the **Embraco Product catalogue** on www.embraco.com

10.6.1 GUIDE LINE FOR USE OF HFCs R134A, R404A AND R407C



All operations related to the use of refrigerants shall be performed only by trained and qualified technicians and in accordance with applicable International and National standards, laws and regulations related to this subject.



Users must have available and understand the applicable HFCs Material Safety Data Sheets (MSDSs).

10.6.1.1 HFCs R134A, R404A, R407C GENERAL INFORMATION

Table 10.6.1.1 R134a, R404A and R407C characteristics

ACCORDING TO EN378	R134a	R404A	R407C
Chemical Name	1,1,1,2-tetrafluoroethane	Mixture R-125/143a/134a	Mixture R-32/125/134a
Molecular Formula	CH ₂ FCF ₃	weight % (44/52/4)	Weight % (23/25/52)
Safety Class	A1	A1	A1
PED fluid group	2	2	2
Practical Limit [kg/m ³]	0.25	0.52	0.31
ATEL/ODL [kg/m ³]	0.21	0.52	0.29
LFL [kg/m ³]	NF (*)	NF (*)	NF (*)
Vapour density 25°C, 101.3 kPa [kg/m ³]	4.17	3.99	3.53
Molecular Mass [g/mol]	102	97.6	86.2
Normal Boiling Point [°C]	-26	- 46.5 to - 45.7	- 43.8 to - 36.7
ODP	0	0	0
GWP [100 yr ITH]	1430	3922	1774
Autoignition temperature [°C]	743	728	704
Critical Temperature [°C]	101.06	72.12	86.139
Critical Pressure [kPa abs]	4059.3	3734,9	4639.4
Temperature glide at 1 bar abs pressure [K]	-	0.75	7 (zeotropic blend)

(*) NF signifies non-flammable

Note: HFC refrigerants are classified in Safety Class A1 - lower toxicity, no flame propagation, (according to ISO817).

10.6.1.2 SYSTEM COMPONENTS COMPATIBILITY

All refrigeration system components shall be compatible with the R134a, R404A, R407C respectively used and the lubricant charged in the compressor. Substances containing **chlorine, mineral oils, paraffin and silicone** are not allowed.



All equipment used in the refrigerator manufacturing process that require lubrication and may come into contact with the refrigeration system components, must use exclusively polyolester oil as a lubricant (suggested viscosity 18 - 20 cSt @ 40°C).

Particular attention must be given to the internal cleanliness of the system (see Chapter **10.3.1**), avoid entering into the system of any solid residues (dust, brazing flux, metal particles, etc.), humidity and free of debris or any particles including copper residues.

10.6.1.3 SYSTEM EVACUATION

Before charging, the system shall be tested for leaks (refer to applicable standards like EN378 or similar).



If the leak test is made by pressurizing the system keep the pressure inside the compressor below 16 bars (see Chapter **7.6**).



Do not mix HFCs and air to control leaks in the system.
Contact the refrigerant supplier for detailed information.

Good refrigeration practice suggests system evacuation from both low side and high side, achieving a residual absolute pressure level lower than of 0.14 mbar (14 Pa or 100 µHg), measured at its stabilization on both the low and high pressure sides.

The residual non-condensable in the system should be less than 0.3% by volume of the refrigerant charged into the system.



Adopt vacuum pumps suitable for use of the HFCs. They should be dedicated to the specific refrigerant normally used (R134a, or R404A or R407C). Consult the manufactures to learn procedures for using the same pump with different refrigerants.



To avoid damages to the compressor, never start or perform high voltage test under vacuum (without refrigerant charge). Always "break the vacuum" with refrigerant (at least with pressure equivalent to the saturation at -10°C) before applying power to the compressor. If power is applied with the system under vacuum, with the conductivity of the air at low pressure, an electrical discharge arc may trigger between pins and shell of the compressor damaging the pins insulation glass. The damage may be immediately evident at the first starting of the compressor or remain latent and appear after the system has operated for a certain time in the field, with risk of fire, especially with HCs refrigerants.

10.6.1.4 REFRIGERANT CHARGE



Avoid that liquid or gasous refrigerants from vessel under pressure come in contacts with human body. Skin, eyes may be permanently damaged: use protective devices (gloves, glasses).

Refrigerant charge amount depends from the internal volume of the system, its design and working conditions, from the type of refrigerants and safety limits.

For each system, the optimal refrigerant charge should be determined by appropriate labs tests in order to optimize the working conditions and energy consumption.

Effort should be done to minimize the refrigerant charge.



Refrigerant should preferably be charged into the liquid line after the condenser.

In case the refrigerant is charged into the compressor^(*), and the quantity is approaching or exceeding the max admitted refrigerant charge (see *Table 10.6.1.5*) connect the charging line to the compressor process tube and allow the refrigerant entering at vapor state: when the refrigerant vapor reach a pressure equivalent to the saturation pressure of 5 to 10°C, start the compressor and continue to charge the refrigerant at vapor state until the final charge is reached.

() After charging refrigerant into the compressor, wait at least 5 minutes before starting the compressor, in order to allow the evaporation of the refrigerant.*

In case of different charging procedures, contact Embraco Technical support team for assistance.

Use a filter drier in the refrigerant charging line.



Do not exchange the use of the suction and service tube. Charging the refrigerant through the suction tube may damage the intake muffler and cause abnormal overpressure at the first system startup, with possible damage of the valves and head gaskets.



Refrigerant blends (R404A, R507A, R407C) must be dawning off by the vessel in liquid state and the flow must be adjusted in order to obtain it in the vapor state at the compressor process tube.

In case the refrigerant charging procedures of the OEMs cause liquid flood back (also evidenced by typical noise) or starting problems, contact Embraco Technical support team for assistance.

Adopt charging equipment suitable for use of the HFCs. It should be dedicated to the specific refrigerant normally used (R134a, or R404A/R507A, or R407C). Consult the charging equipment manufactures to learn if it must be reconverted in case more than one of these refrigerants are used with the same equipment.

10.6.1.5 EMBRACO COMPRESSOR MAX REFRIGERANT CHARGE

Embraco prescribe a technical limit of refrigerant charge of the systems according to below **Table 10.6.1.5**, for HFC and HC refrigerants, which do not require special precautions at the compressor startup after a prolonged stop.

Table 10.6.1.5 Max refrigerant charge admitted in the Embraco compressors

SERIES	EM	NE/VNE	NT	NJ
Max. refrigerant charge for HFC (g)	250	350	800	800
Max. refrigerant charge for HC (g)	150	250	400	500



From safety and reliability reasons, it is always recommended to minimize the refrigerant charge as low as possible.

10.6.1.6 ALTERNATIVE REFRIGERANTS

Embraco performed extended testing program on different alternative refrigerants, and conclusions are described below in Chapters **10.6.1.6.a** and **10.6.1.6.b**

Table 10.6.1.6 R452A, R449A, R448A, R513A and R450A characteristics

ACCORDING TO EN378	R452A	R449A	R448A	R513A	R450A
Chemical Name	Mixture R32/R125/R1234yf	Mixture R32/R125/R1234yf/R134a	Mixture R32/R125/R1234yf/R134a/R1234ze(E)	Mixture R134a/R1234yf	Mixture R134a/R1234ze(E)
Molecular Formula	weight % (11/59/30)	weight % (24.3/24.7/25.3/25.7)	weight % (26/26/20/21/7)	weight % (44/56)	weight % (42/58)
Safety Class	A1	A1	A1	A1	A1
PED fluid group	2	2	2	2	2
Practical Limit [kg/m³]	0.423	0.357	0.388	0.319	0.319
ATEL/ODL [kg/m³]	0.423	0.357	0.388	0.319	0.345
LFL [kg/m³]	NF (*)	NF (*)	NF (*)	NF (*)	NF (*)
Vapour density 25°C, 101.3 kPa [kg/m³]	4.30	3.62	3.58	4.256	4.54
Molecular Mass [g/mol]	103.51	87.21	86.28	108.4	108.67
Normal Boiling Point [°C]	-47 to -43.2	-46 to -39.9	-45.9 to -39.8	-29.05	-23.4 to -22.8
ODP	0	0	0	0	0
GWP [100 yr ITH]	2140	1397	1387	631.4	604.7
Autoignition temperature [°C]	ND	ND	ND	ND	ND
Critical Temperature [°C]	74.9	81.5	83.7	96.5	104.4
Critical Pressure [kPa abs]	4001.7	4447	4660	3766	3820
Temperature glide at 1 bar abs pressure [K]	3.8	6.1	6.3	0.1	0.8

(*) NF signifies non-flammable.

Note: HFC refrigerants (R452A, R449A, R448A, R513A and R450A) are classified in Safety Class A1 - lower toxicity, no flame propagation, (according to ISO817).

10.6.1.6a R404A

R452A is presenting the same or lower thermal profile when compared with R404A. Therefore, Embraco approves R452A as an alternative refrigerant for all Embraco R404A compressor series and authorize its use, both in LBP and MBP applications, maintaining the same operating envelope of R404A refrigerant and other Embraco application guidelines as for example the system charge limitations defined for each Embraco compressor family.

R448A and **R449A** testing indicate relatively higher temperature level than R404A. Usage of those refrigerants may require system changes such as, system condensing temperature reduction (larger condenser, improved ventilation) or return gas temperature reduction in order to achieve a similar thermal profile as with refrigerant R404A. To maintain Embraco warranty, final application needs to be validated by Embraco Technical Support Team case by case. Usage in systems operating under high compression ratio conditions in particular should be avoided.

10.6.1.6b R134a

Embraco approves **R513A** as well as **R450A** as alternative refrigerants for Embraco R134a compressors and authorize its use, both in LBP and HBP applications, maintaining the same operating envelope of R134a refrigerant and other Embraco application guidelines as for example the system charge limitations defined for each Embraco compressor family.

Refrigerant R513A, according to the calorimetric evaluation is showing no impact on cooling capacity while refrigerant R450A is showing drop of cooling capacity about 12% in average, when tested at calorimeter. Actual impact on performances has to be verified on specific application. Embraco R134a compressors, using R450A and R513A, are maintaining the same electrical components and are showing the same reliability as with R134a refrigerant.

10.6.2 GUIDE FOR THE USE OF HCs REFRIGERANTS R600a AND R290 - SAFETY WARNINGS



The R600a and R290 are hydrocarbon (HCs) refrigerants. Their flammability and other different characteristics versus other refrigerants (HFCs, HCFCs) must be considered for the entire cycle of the applications (from design to disposal), including production and repairing work places, installation, servicing.

Embraco recommends to the HCs equipment producers, installers, repairs to carry out a complete risk assessment considering all the elements and components related to the use of HCs refrigerants, including the production/repairing/testing workplaces, storage of finished systems, installation in the field, use, repairing and disposal and to adopt all the actions to minimize the risks. The potential explosive ambient where the systems are produced or repaired must be properly ventilated, free from ignition sources and equipped with leak detectors. All the equipments must comply with the safety requirements of flammable refrigerants.

Therefore:

A complete risk assessment of the use of HCs refrigerants must be carried out considering all the above points when Embraco compressor is applied on the refrigerating equipment.

The use of HCs refrigerants in refrigeration is actually regulated by international/regional/national safety standards as product family standards, especially IEC/EN/UL 60335-2-24, -2-40, -2-89 or by horizontal generic standard, especially EN378, ISO5149, ASHRAE 15. Above mentioned standards fix charge limits according to the application design, location where it is installed and public accessibility.

Please note, that product family standards dealing with the safety of refrigerating systems takes precedence over horizontal and generic standards covering the same subject. International, regional and national standards can be overruled by local rules (like building codes, ministerial decree, fire marshal or other local authorities' decisions, etc) that apply to potential explosive atmospheres, must be followed. While using equipment with Embraco hydrocarbon compressors (R290 and R600a) you should comply with all the standards and codes from your jurisdiction.



Embraco requires that only competent technicians trained on the safe use of HCs are allowed to intervene on systems where is required the opening of the refrigeration circuit.

Technicians using HCs must have available and know the meaning of the applicable Material Safety Data Sheets (MSDSs) and act accordingly.

10.6.2.1 HCs R600a AND R290 GENERAL INFORMATION

Table 10.6.2.1 R600a and R290 characteristics

ACCORDING TO EN378	R600a	R290
Chemical Name	Isobutane (2-methylpropane)	Propane
Molecular Formula	C ₄ H ₁₀	C ₃ H ₈
Safety Class (1)	A3	A3
PED fluid group	1	1
Practical Limit [kg/m ³] (2)	0.011	0.008
ATEL/ODL [kg/m ³]	0.059	0.09
LFL [kg/m ³]	0.043	0.038
Vapour density 25°C, 101.3 kPa [kg/m ³]	2.38	1.8
Molecular Mass [g/mol]	58.1	44.0
Normal Boiling Point [°C]	-12	-42
ODP	0	0
GWP [100 yr ITH]	3	3
Autoignition temperature [°C]	460	470
Critical Temperature [°C]	134.66	96.74
Critical Pressure [kPa abs]	3629	4251.2

(1) Highly flammable substances are defined by a lower flammability limit of less than or equal to 0.10 kg/m³ at 21°C and 101 kPa or a heat of combustion greater than or equal to 19 kJ/kg; (according to ISO817, classified in Safety Class A3 – lower toxicity, higher flammability).

(2) Practical limit according to EN 378-1: it is used if the HC refrigerant of the system can leak into an occupied ambient.

10.6.2.2 R600a AND R290 PURITY

Use refrigerant with technical grade 99.5 % per weight purity (test method SYNTH-GC). For the remaining 0.5 % refer to ISO817 or equivalent standards. However sulfur should be < 1ppm wt (SYNTH-TS), water < 10 ppm wt (SYNTH-TU) and unsaturated hydrocarbons < 250 ppm V (SYNTH-GC).

10.6.2.3 EMBRACO R600a AND R290 IDENTIFICATION AND WARNING SYMBOLS

The Embraco compressors for R600a and R290 have on the nameplate label - or as separate label - a warning symbol for flammable substances, even if they do not contain any refrigerants when delivered from Embraco factories.

Figure 10.6.2.3 Warning symbol



The refrigerant to be used is printed on the compressor label, also the compressor model includes a code identifying the refrigerant to be used (see Chapter 5.2).

The R600a and R290 Embraco compressors are certificated by recognized testing agencies (with IEC/EN 60335-2-34) and adopt overload protectors and starting relay complying with the relevant requirements of EN 60079-15. However Embraco cannot guarantee that the compliance with the applicable standards eliminates all the possible risk of fire.

10.6.2.4 SAFETY WARNINGS



The Embraco R600a and R290 compressors are only allowed to be installed on cabinets fulfilling the requirements for the safe use of flammable refrigerants (like the EN60335-2-24 / 89 for cabinets with less than 150 g for each separated refrigeration circuit) and intended to obtain the approvals from certification bodies.

For systems with the limit of 150g for each separated refrigeration circuit there are no restrictions in room size and occupancy category, however they must be located in ambient having minimal volume to ensure the practical limit (see Table 10.6.2.1) is not exceeded.

Refrigerant charge higher than 150g may be used provided all the applicable regulations and standards (like EN 378 or similar) are respected as well as safety regulations locally applied. These regulations include restriction in room size and occupancy category.

In case of use of refrigerant charge higher than 150g, consult with Embraco Technical support team.

Embraco recommend to the HCs equipment producers, installers, repairs to carry out a complete risk assessment considering all the elements and components related to the use of HCs refrigerants, including the production/repairing/testing workplaces, storage of finished systems, installation in the field, use, repairing and disposal and to adopt all the actions to minimize the risks.



The potential explosive ambient where the system are produced or repaired must be properly ventilated, free from ignition sources and equipped with leak detectors. All the equipments must comply with the safety requirements of flammable refrigerants.

10.6.2.5 SYSTEM COMPONENTS COMPATIBILITY

All refrigeration system components shall be compatible with the refrigerant R600a or R290 respectively used and the lubricant charged in the compressor as indicated in the **Embraco Product catalogue** on www.embraco.com. Compatibility data can be obtained from the refrigerant suppliers. Substances containing chlorine and silicone are not allowed

10.6.2.6 EXPANSION DEVICES

Capillary tubes:

Generally, when changing a system from R134a to R600a ones, for preliminary capillary selection the same capillary sizing can be adopted. The same criterion is valid also when changing from R404A to R290 (practical experience have demonstrated when changing from R404A to R290, is preferable a length increase of approximately 10 %). See Chapter **10.7**.

For preparing a prototype of a new refrigeration system, the capillary tube selection tables (Chapter 10.7) based on practical experience, can be considered as a first reference.

For each system, the optimal dimensioning of the capillary tube should be determined by appropriate tests in the application labs, in order to optimize the working conditions, performance and energy consumption and to minimize the refrigerant charge and ensuring that the compressor works within its admitted limits.

It is not recommended to use a capillary tube with an internal diameter lower than 0.6 mm.

Thermostatic expansion valve:

Thermostatic valve manufactures have available products for R290 (normally R600a is adopted in small systems that don't use TXV). Contact them for guide for the valve selection and instructions for the applications.

10.6.2.7 LIQUID AND SUCTION LINE TUBES

When designing refrigerant lines, specific hydrocarbon refrigerant pipe sizing literature should be examined. The criteria indicated on Chapter **10.3.2** may only represent a first reference. Normally the line tubes of HCs system have smaller inner diameter to minimize the refrigerant charge; the specific volume and ability of carrying the oil back to the compressor are different than HFCs and need to be considered.

10.6.2.8 EVAPORATORS AND CONDENSERS

The evaporator and condenser used for R134a and R404A may represent only an initial reference respectively for R600a and R290, as thermodynamic and oil transport property are different and design valid for other refrigerants are not directly applicable.

The evaporator internal design may need revision due to the different thermodynamic characteristics, volume flow and oil transport of R600a and R290 vs R134a and R404A respectively. It is necessary to verify that the refrigerant flow velocity assures the oil return to the compressor.



There may have regions in multiple channels or even single channel circuits that may tend to trap oil.

Eventual liquid accumulator requires a careful design. R600a and R290 are lighter than the oil used in the compressors (R134a and R404A are heavier) and the oil can be trapped in the liquid accumulator if it is not properly designed. This applies also to the "cells" accumulators at the end of the roll-bond evaporators.



With R290, the design of the Al roll-bond evaporator shall take into consideration the high burst pressure required by the safety standards.

10.6.2.9 WATER TRAY



Due to the low isentropic coefficients of R600a and R290 and to the high efficiency solution of the Embraco compressors, the compressor shell and discharge temperature with these refrigerants are lower than the ones using HFCs (see *Table 11.4*). Therefore it will be necessary to check the consequent evaporative effect of the water tray eventually installed on the compressor shell or in the cabinet base plate, adopting the necessary modifications.

10.6.2.10 FILTER DRYER

Refrigerants R600a and R290 require the use of a normal filter dryer, see Chapter **10.4**. Always consult the manufacturer for the proper selection of the filter dryer.

10.6.2.11 SYSTEM COMPONENTS BRAZING



Special attention must be dedicated when performing the brazing, or other forms of union of the system components, to avoid the possibility of flammable refrigerant leaks.

For brazing procedure refer to Chapter **10.5**.

Use of brazing torches is allowed only on new cabinets before the refrigerant is charged into the system. After charging, the service tube should be sealed with lock-ring or ultrasonic brazing apparatus

10.6.2.12 SYSTEM EVACUATION

Generally the vacuum level for an R600a and R290 systems is the same used for a system with R134a and R404A (see Chapter **10.6.1.3**).



Good refrigeration practice suggests evacuation from both low side and high side and achieving a minimum level of 0.14 mbar (14 Pa or 100 µHg), with a non condensable residual value of less than 0.3% by volume. Due to the small pressure difference between inlet-outlet of the expansion devices of R600a systems, performance/noise are more adversely influenced by high non condensable residual than systems using other higher pressure refrigerants.

Vacuum pump (that may be used on systems that has been repaired after the refrigerant charge) shall be suitable for safety use on systems using HCs, consult the producers for detailed information.



Never start compressor under vacuum, see Chapter **10.6.1.3**.

10.6.2.13 REFRIGERANT CHARGE



Test carefully the system for leakages before charging the refrigerant. Leak detection with Helium is recommended.



If the leak test is made by pressurizing the system keep the pressure inside the compressor below 16 bar (see Chapter **7.6**).

Higher pressure may deform the compressor shell and terminal pin holders and lead to eventual cracks on the insulation glass with refrigerant leaks and possible grounding of the pins. This will generate flame/explosion especially in case of HCs refrigerant are used.

Generally the quantity of the refrigerant R600a or R290 charged into the systems can be reduced from 40 – 50 % compared to the required charge of R134a or R404A respectively.

For each system, the optimal refrigerant charge should be determined by appropriate lab tests in order to obtain the best working conditions and minimum energy consumption.

Efforts should be done to minimize the refrigerant charge in order to reduce the risk of flammability and its consequences, see Safety warnings in Chapter **10.6.2.4**.



Do not exchange the use of the suction and service tube. Charging the refrigerant through the suction tube may damage the intake muffler and cause abnormal overpressure at the system startup, with possible damages of the valves and gaskets, see Chapter **10.6.1.4**.



R600a and R290 are single component fluids and can be charged into the systems either in the liquid or vapor state. After charging refrigerant into the compressor, wait at least 5 minutes before starting the compressor, in order to allow the evaporation of the refrigerant.



Use charging equipment suitable for use in potential explosive ambient (ATEX approved or similar) for the refrigerant R600a and R290. Contact the producers for details information and instructions.

10.6.2.14 MAXIMUM REFRIGERANT CHARGE



Provided that all the applicable regulations and standards are respected, in case the refrigerant charge of the system exceeds 150 g, see *Table 10.6.1.5* and the precaution of Chapter **10.3.4**.



Due to the relative small amount of the HCs refrigerant charge and the influence of its variation on the application performance and energy consumption, it is recommended to measure the refrigerant charge with the needed accuracy (normally 1%).

10.6.2.15 LEAK CONTROL

For checks after refrigerant charging, use a leak detector designed for refrigerants R600a and R290. Contact the apparatus producers for detailed information and instructions



Due to the risk related to leaks of flammable refrigerants and the impact on performance for the small amount of the refrigerant charge, the leak detectors should have a sensitivity of less than 3 g/year.

10.7 CAPILLARY TUBES SIZE

During the initial steps of the design of a new cabinet, tables of Chapter **10.7.1 (a-g)** can provide guidance for starting with the selection of the appropriate capillary tube dimensions.

They represent capillaries adopted in practical on systems performing properly and requiring a cooling capacity indicated on the below tables, corresponding to the Embraco compressor rated cooling capacity, for the various refrigerants and applications.



The exact size of the capillary must however be determined according to the results of laboratory tests performed on prototype cabinets. For this reason the capillary here indicated are classified as “suggested capillary for preliminary selection”.

The capillary sizing indicated on *Tables 10.7.1 (a-g)* refers to cabinets adopting a suction line heat exchanger of minimum length 0.9 m and with 0°C sub-cooling, working within the indicated range of evaporating temperature.

10.7.1 SUGGESTED CAPILLARY FOR PRELIMINARY SELECTION

Table 10.7.1a R600a LBP applications

Compressor Rated cooling capacity (W)			Dimension I.D. (mm) x length (m)	
CECOMAF	ASHRAE (*)	ARI 540 (2004) (*)	Evaporating temperature -30°C to -20°C	Evaporating temperature -20°C to -5°C
40 - 60	60 - 80	50 - 70	0.66 x 4.00	0.66 x 3.45
60 - 75	80 - 105	70 - 90	0.78 x 3.50	0.78 x 3.10
75 - 100	105 - 140	90 - 120	0.78 x 3.20	0.91 x 3.20
100 - 125	140 - 175	120 - 150	0.78 x 3.00	0.91 x 3.00
125 - 150	175 - 210	150 - 180	0.78 x 2.70	0.91 x 2.60
150 - 180	210 - 250	180 - 215	0.91 x 3.60	1.06 x 3.60

(*): Approximate equivalent cooling capacity to the Cecomaf.

Table 10.7.1b R600a HBP applications

Compressor Rated cooling capacity (W)			Dimension I.D. (mm) x length (m)	
EN12900 (*)	ASHRAE	ARI 540 (2004) (*)	Evaporating temperature -15°C to -5°C	Evaporating temperature -5°C to +10°C
250 - 300	275 - 350	250 - 320	0.78 x 2.50	0.91 x 2.40
			0.78 x 2.10	0.91 x 2.00
300 - 400	350 - 450	320 - 400	0.78 x 2.40	0.91 x 2.30
400 - 500	450 - 570	400 - 520	0.78 x 2.30	0.91 x 2.20
500 - 650	570 - 750	520 - 675	0.91 x 2.90	1.06 x 2.70
650 - 750	750 - 850	675 - 775	0.91 x 2.40	1.06 x 2.50
750 - 900	850 - 1000	775 - 900	1.06 x 3.20	1.27 x 3.30

(*): Approximate equivalent cooling capacity to the Ashrae HBP

Table 10.7.1c R134a LBP applications

Compressor Rated cooling capacity (W)			Dimension I.D. (mm) x length (m)	
EN12900 (*)	ASHRAE	ARI 540 (2004) (*)	Evaporating temperature -35°C to -20°C	Evaporating temperature -20°C to -5°C
35 - 45	70 - 90	60 - 75	0.61 x 4.00	0.61 x 3.50
45 - 55	90 - 120	75 - 95	0.78 x 4.00	0.91 x 4.00
55 - 65	110 - 130	95 - 110	0.78 x 3.70	0.91 x 3.70
65 - 80	130 - 160	110 - 135	0.78 x 3.50	0.91 x 3.50
80 - 95	160 - 190	135 - 160	0.78 x 3.30	0.91 x 3.30
95 - 110	190 - 220	160 - 190	0.91 x 4.00	1.06 x 4.00
110 - 150	220 - 300	190 - 255	0.91 x 3.30	1.06 x 3.30
150 - 200	300 - 400	255 - 350	0.91 x 2.90	1.06 x 3.00
200 - 250	400 - 500	350 - 425	1.06 x 3.25	1.06 x 2.50
250 - 345	500 - 680	425 - 610	1.06 x 3.00	1.20 x 3.50

(*): Approximate equivalent cooling capacity to the EN12900

Table 10.7.1d R134a HBP Applications

Compressor Rated cooling capacity (W)			Dimension I.D. (mm) x length (m)	
EN12900 (*)	ASHRAE	ARI 540 (2004) (*)	Evaporating temperature -15°C to -5°C	Evaporating temperature -5°C to +10°C
250 - 300	275 - 350	250 - 320	0.78 x 2.50	0.91 x 2.40
			0.78 x 2.10	0.91 x 2.00
300 - 400	350 - 450	320 - 400	0.78 x 2.40	0.91 x 2.30
400 - 500	450 - 570	400 - 520	0.78 x 2.30	0.91 x 2.20
500 - 650	570 - 750	520 - 675	0.91 x 2.90	1.06 x 2.70
650 - 750	750 - 850	675 - 775	0.91 x 2.40	1.06 x 2.50
750 - 900	850 - 1000	775 - 900	1.06 x 3.20	1.27 x 3.30
900 - 1200	1000 - 1350	900 - 1250	1.24 x 4.00	1.37 x 3.30
1200 - 1500	1350 - 1700	1250 - 1550	1.37 x 3.50	1.50 x 3.30
1500 - 2000	1700 - 2300	1550 - 2100	1.37 x 3.10	1.50 x 2.90
2000 - 2500	2300 - 2850	2100 - 2600	1.63 x 3.60	1.78 x 3.30
2500 - 3000	2850 - 3500	2600 - 3200	2x1.50 x 4.00	2x1.63 x 3.00

(*): Approximate equivalent cooling capacity to the Ashrae HBP

Table 10.7.1e R290 (*) - R404A - R507A LBP applications**

Compressor Rated cooling capacity (W)			Dimension I.D. (mm) x length (m)	
EN12900 (*)	Ashrae	ARI 540 (2004) (*)	Evaporating temperature -40°C to -20°C	Evaporating temperature -20°C to -10°C
120 - 145	230 - 280	170 - 210	0.78 x 3.80	0.78 x 2.70
150 - 185	280 - 355	210 - 265	0.91 x 4.00	0.91 x 2.80
185 - 260	335 - 500	250 - 375	0.91 x 3.10	0.91 x 2.20
260 - 340	500 - 650	375 - 480	0.91 x 2.70	1.20 x 2.80
340 - 390	650 - 750	480 - 560	1.20 x 3.40	1.20 x 2.50
390 - 470	750 - 900	560 - 675	1.20 x 3.10	1.20 x 2.20
470 - 550	900 - 1050	675 - 800	1.20 x 2.90	1.40 x 3.00
550 - 640	1050 - 1400	800 - 1050	1.40 x 3.50	1.40 x 2.60
730 - 900	1400 - 1750	1050 - 1300	1.60 x 3.50	1.60 x 2.70

(*): practical experience have demonstrated when changing from R404A to R290, is preferable a length increase of aprox 10 %

(**): Approximate equivalent cooling capacity to the Ashrae LBP

Table 10.7.1f R290 ()** – R404A – R507A – R407C M/HBP application

Compressor Rated cooling capacity (W)			Dimension I.D. (mm) x length (m)	
Ashrae	EN12900MBP (**)	ARI 540 MBP (**)	Evaporating temperature -20°C to -5°C	Evaporating temperature -5°C to +10°C
650 - 750	350 - 400	350 - 400	1.06 x 3.30	1.06 x 2.80
750 - 850	400 - 450	400 - 450	1.06 x 3.10	1.06 x 2.55
850 - 1000	450 - 550	450 - 550	1.06 x 2.80	1.20 x 3.30
1000 - 1200	550 - 650	550 - 650	1.20 x 3.00	1.20 x 2.35
1200 - 1600	650 - 850	650 - 850	1.20 x 2.75	1.27 x 2.45
1600 - 2000	850 - 1050	850 - 1050	1.27 x 2.55	1.27 x 1.80
2000 - 2400	1050 - 1250	1050 - 1250	1.27 x 2.15	1.27 x 1.50
2400 - 2800	1250 - 1500	1250 - 1500	1.37 x 1.90	1.37 x 1.50
2800 - 3300	1500 - 1750	1500 - 1750	1.63 x 2.75	1.63 x 1.60
3300 - 3800	1750 - 2000	1750 - 2000	1.90 x 2.65	2.16 x 2.05
3800 - 4500	2000 - 2400	2000 - 2400	2.16 x 2.45	2x1.63 x 1.70
4500 - 5700	2400 - 4200	2400 - 4200	2.16 x 1.90	2x2.16 x 2.35

(*): practical experience have demonstrated when changing from R404A to R290, is preferable a length increase of aprox 10 %

()**: Approximate equivalent cooling capacity to the Ashrae M/HBP

Note: Compressor test conditions see in Table 5.5

10.8 RUBBER GROMMETS AND SLEEVES

Alternating forces of first order, such as rotating masses and masses having rectilinear alternating motion, are duly balanced inside the compressor. Inertial alternating forces of greater order are not balanced; however, they are partially absorbed by internal suspension springs and by the rubber grommets, when correctly applied to the external mounting base. The rubber grommets and the sleeves have been selected in order to guarantee the following characteristics:

- Reduction of vibrations transmission of more than 50%.
- Partial adsorption of inertial, tangential forces and relative moments, particularly noticeable at compressor start and stop.

The components of this external suspension system are supplied partly by Embraco (rubber grommets and sleeves) while the remaining components for their blocking - screws, washers and nuts (or suitable alternate systems), must be sourced by the customer.

As an alternative solution to grommets and sleeves Embraco compressors may be supplied with "Snap-on" fixation (rubber grommet, pin and clamp), see *Figure 10.8.1* – Pin and clamp. The components of this external fixation are fully supplied by Embraco.



It is very important that these components are assembled correctly in order to guarantee, as indicated in *Figure 10.8.1* – A Correct mounting, the proper clearance between the rubber grommet and flat washer, fixed between nut and sleeve – version with screw and nut.

This clearance, avoiding an abnormal compression of the rubber grommet (*Figure 10.8.1* – B Incorrect mounting), allows the proper damping of the vibrations transmitted by the compressor.

For each compressor serie, a rubber grommet has been defined to be coupled to the relative sleeve or pin with clamp as indicated in *Figure 10.8.2*.

The use of grommets and sleeves different from the ones designated may increase the transmission of vibrations, resulting in noise increase.



The compressor must be maintained in vertical position during the production process of the finished cabinet, including the mounting of the grommets and sleeves (see Chapter **10.2**).

10.8.1 RUBBER GROMMETS ASSEMBLY

Figure 10.8.1 Rubber grommets assembling scheme

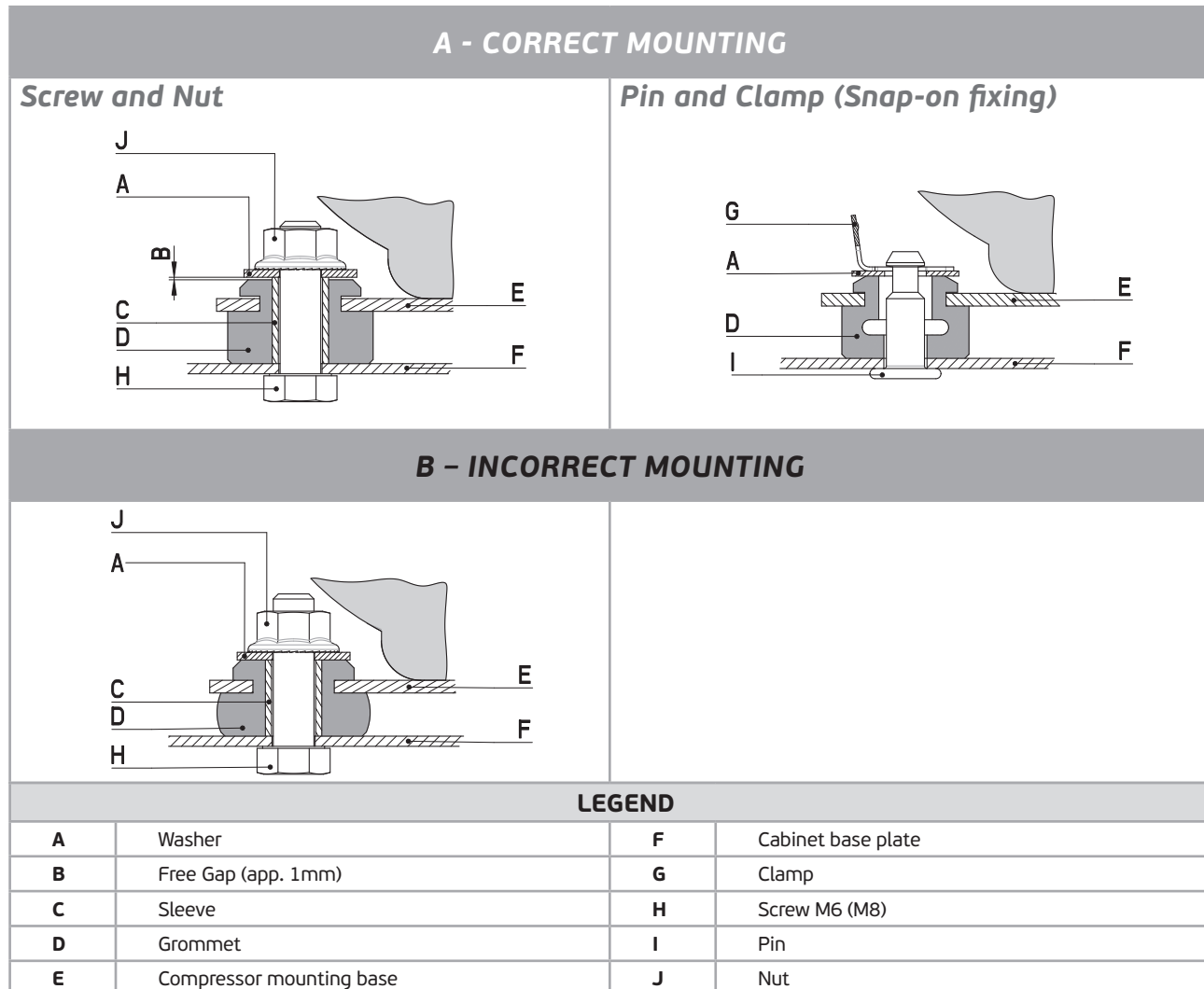

10.8.2 RUBBER GROMMETS/SLEEVES DIMENSION

Table 10.8.2 Rubber grommets/sleeves dimensions

CODE	A	B	C	D	E	F	G	H	L	M	N	P	Q	R	S	T
AM01	17.2	9	6.6	16.5	4.9	3		10.3	3	20.5	16	10.5	8.5		17	25
AM02	16.6	11.1	8.7	16.5				10.3	3	23.8	17.5	11.1				28.6
AM03	18.3	11.1	8.7	17.5			4.7	9.5	4	23.3	19	11.1		17.5		31.8
AM05	23	11.1	8.7	23	9.4	3.2	3.2	15	4	23.8	19	14.3	10.6	19	23.5	31.7
AM06	23.5	7.5		16.5	4.9	3		10.3	3	20.5	16	10.5	8.5		17	25

Figure 10.8.2 Rubber grommets and sleeves

SERIE			
EM, NE (with European base plate)	AM01	2221011	2222018
NE (non standard)	AM02	2221001	2222014
NE (with Universal base plate)	AM03	2221003	2222015
NT, NJ	AM05	2221004	2222016
Snap-on EM, NE (with European base plate)	AM06	2221011	2037140

10.9 ROTOLOCK VALVES

For NJ and NT series compressors, upon customer's request, can be supplied a special version having, in place of the suction tube, a threaded union brazed on the cover of the housing, suitable for fixing a Rotolock suction valve.

A cap screwed on the union guarantees its protection and the internal pressurization of the compressor. This special version can be supplied in two ways:

- Compressor with union for valve, without supplying the Rotolock valve
- Compressor with union for valve, supplying also unassembled Rotolock valve, equipped with the appropriate sealing gasket

The threading of the union of 1" - 14 NS-2 accepts Rotolock valves with different dimensions according to the compressor type, as indicated in the **Embraco Product catalogue** on www.embraco.com

The assembly of the valve on the compressor union must be done by inserting the gasket on its seat on the union, after dampening both with light oil film (of the same type charged into the compressor). The valve nut should be tightened to the torque indicated in the *Table 10.9.1*. The valve can be oriented, as necessary, within 360°.



Use a new gasket seal in case of replacement of the Rotolock valve.

10.9.1 ROTOLOCK TIGHTENING TORQUES

Table 10.9.1 Recommended tightening torques for In/Out valves

Component legend	Component name	Dimension	Torque specification (Nm)
1	Spindle		10 – 12
2	Process or Manometer port	1/4"	7 – 11.5
3	Pressostat port	1/4"	7 – 11.5
4	Rotolock connection	1" – 14UNS	67 – 82
5	Inlet/Outlet connection for customer		
6	Nut	1/4"	14.5 – 17.5
6	Nut	3/8"	21.5 – 26.5
6	Nut	1/2"	33.2 – 38.7
6	Nut	5/8"	43.1 – 47.0



The opening and closing of valve spindle can be effected with electric or pneumatic drivers having a speed lower than 360 rpm. Higher speed damages the spindle and valve body tightness seats.

Figure 10.9.1 Rotolock valve types

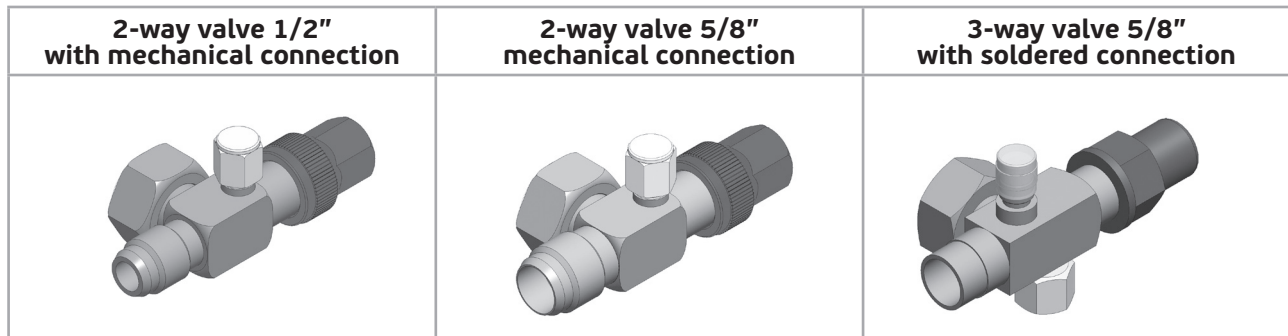

The Rotolock valve can be supplied for mechanical connection (flared and nut) or for soldered connections to the line tubes, as indicated in Figure 10.9.1.



For the soldered version, in order to avoid overheating during brazing, which can damage the gasket, we recommend to effect the brazing before applying the gasket, and then connect the valve to the compressor. It is a good practice to keep the brazing time to a minimum in order to not overheat the spindle tightness, even if it is produced with material resistant to high temperatures. For other brazing information see Chapter 10.5.

10.9.2 VALVE SYSTEM POSITION

Figure 10.9.2 Valves position

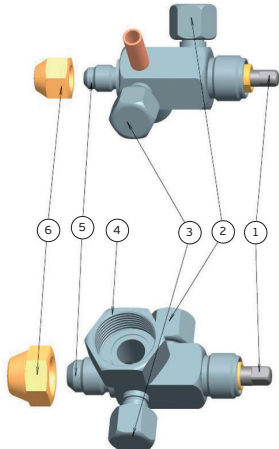

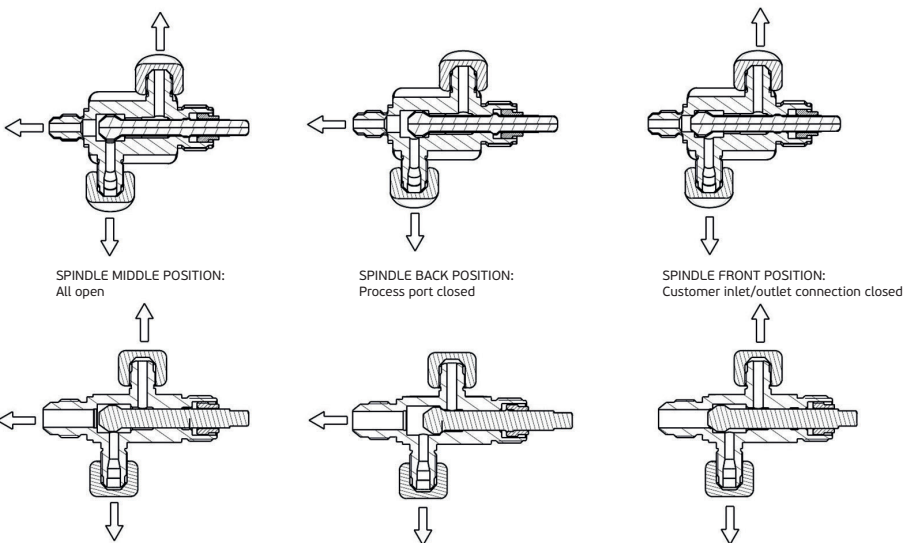

TORQUE SPECIFICATIONS:		
1	SPINDLE	10 - 12 Nm
2	PROCESS OR MANOMETER PORT 1/4" SAE	7 - 11.5 Nm
3	PRESSOSTAT PORT 1/4" SAE	7 - 11.5 Nm
4	ROTOLOCK CONNECTION 1" - 14UNS	67 - 82 Nm
5	INLET/OUTLET CONNECTION FOR CUSTOMER	
6	NUT 1/4"	14.5 - 17.5 Nm
6	NUT 3/8"	21.5 - 26.5 Nm
6	NUT 1/2"	33.2 - 38.7 Nm
6	NUT 5/8"	43.1 - 47.0 Nm

Note: the port for the connection with the pressostat may never be closed.



Do not install a system and leave it unattended with the service valves closed. This will prevent from people accidentally operating the system and potentially damaging the compressor and/or generating dangerous high pressure.

10.10 ELECTRIC SUPPLY

10.10.1 SUPPLY VOLTAGE ADMITTED LIMITS

The compressor assembled on the refrigeration system must be connected to a voltage supply line with characteristics within the limits indicated in *Table 4.4*. Due to voltage drops on the supply circuit, the voltage must be measured at the compressor terminal pins. (*)



(*) As it's not allowed to run the compressor without the terminal cover properly fixed on the terminal fence, this measure must be taken outside the cover, as close as possible to the compressor pins.



For the compressor connection to the electrical supply line and for maintenance/repairing operation, refer also to Appendix 1- Recommendations - safety instruction for compressor installation.

In the *Table 4.4*, are indicated minimum starting voltages at which the compressor can start.

In Chapter **11.6.2** are indicated, for compressor start, the values of balanced and unbalanced pressure conditions.

The correct sizing of the electric supply cables is important to guarantee low voltage drops at compressor start and during running under high load (see Chapter **10.1.7**).



In case of operation of motor-compressor out of working voltage range may result damage of motor-compressor and/or its accessories. In some specific conditions in when working out of operation voltage range, overload protector function may not be assured (see Chapter **10.1.6**).

Voltage drop below the Embraco approved limits may cause a prolonging tart-up of the compressor, with possible damages of it and of other electrical components.

10.10.2 PRELIMINARY SELECTION OF FUSES



The electrical wiring and safety protections must be performed according to the laws and regulations applicable in the country in which the refrigeration system will operate.

11. RUNNING DATA AND COMPRESSOR CHECKING PROCEDURES

The performance and longevity of a refrigeration system is strongly influenced by how the system was designed (and the components selected and matched), processed, installed, used and maintained.



During operation in the field, the system can encounter some factors worsening the working conditions, such the reduction of the effectiveness on the condenser due to clogging, partial leakage of the refrigerant, fan motor failures, etc. Because of these factors, it is recommend to size the system with a good margin and test it under the more severe conditions (normal and abnormal) expected in the field, to ensure that the system will operate within the prescribed limits of Chapter **11** and in safety conditions.

11.1 MINIMUM COMPRESSOR TEMPERATURE



In case of storage at low temperature, before to install the compressor on the refrigeration system, charge and start it, is required to stabilize the compressor in ambient at higher temperature in order to allow it reaching +5°C min. The same criteria are valid also before to electrically supply finished products stored at low ambient temperature.

The compressors are intended for internal usage, however, in case of cabinets working in low ambient temperature, the compressor should be equipped with a crankcase heater to keep the compressor temperature over +5°C. For use of the crankcase heater see Chapter **10.3.4**.

11.2 MAXIMUM TEMPERATURE OF ELECTRIC MOTOR WINDINGS

The temperature of the motor windings should not exceed 130°C max, under normal running conditions.

The wiring temperature can be measured while the compressor is running through suitable equipment (for inst. SILYTESTER of BIDDLE USA), or through the method of ohmic resistance measurement, by disconnecting the compressor supply.



The compressor shall be connected to the supply line only when the hermetic terminal cover is properly fixed. When the compressor is energized, all the electrical measures must be done outside the cover (see Chapter **10.10.1**).

The ohmic resistance measurement method requires the compressor to be stabilized at the ambient temperature and the availability of instruments for measuring the ohmic resistance (digital Ohmmeter, Wheatstone's bridge) and the temperature.

- a) Measure the ohmic resistance R_f of the main winding (run) between the pins of the hermetic terminal C "common" and R "run". Measure the corresponding stabilized reference temperature T_f .
- b) Measure the ohmic resistance R_c of the main winding (run) between the pins C and R with hot motor, at the working conditions to which you intend to measure the motor temperature.
- c) Calculate the above hot motor temperature T_c with the following formula:

Calculation formula for Cu winding:

$$T_c = \frac{(R_c - R_f)}{R_f} (234.5 + T_f) + T_f$$

Calculation formula for Al winding:

$$T_c = \frac{(R_c - R_f)}{R_f} (225 + T_f) + T_f$$

Where:

- T_c = Unknown temperature with hot motor
- T_f = Motor temperature measured at the stabilized reference temperature
- R_c = Measured ohmic resistance, corresponding to the T_c temperature
- R_f = Measured ohmic resistance, corresponding to the T_f temperature

11.3 MAXIMUM DISCHARGE GAS TEMPERATURE

Discharge gas temperature must be kept below the maximum temperature indicated in *Table 11.4*, measured by thermocouples fixed on discharge tube at a distance of 100 mm from the compressor housing and thermally insulated from the surrounding ambient, under stabilized running conditions.



Do not touch the compressor shell or discharge line when the system is running or shortly before its stop, to avoid skin burns.



The compressor shell may reach temperatures close to 150 °C (and the discharge tube even higher) in case of certain system failures (condenser/evaporator fan, refrigerant leaks). Keep away from compressor shell and discharge tube the wiring insulation and other materials which can be damaged by this temperatures.



The plastics used on the cabinets base where is installed the compressor must be self-extinguishing and placed away from the compressor discharge tube.

11. 4 MAXIMUM DISCHARGE GAS PRESSURES AND TEMPERATURES

Systems shall be designed for Maximum operating pressures according to applicable standards (EN 378 or similar applicable standards) that must not be exceeded.



In any case, for Embraco compressors the maximum pressure peak, during “Pull-Down”, the maximum pressures under continuous running and the maximum discharge gas temperature under continuous running, shall be kept below the values indicated in *Table 11.4*.

Table 11.4 Discharge gas maximum pressures/temperature

Refrigerant	PULL-DOWN Maximum peak			Maximum stated condition			Maximum discharge gas temperature stated conditions
	kgf/cm ² (rel.)	Mpa (rel)	bar (rel.)	kgf/cm ² (rel.)	Mpa (rel)	bar (rel.)	°C
R290	20.6	2.0	20.2	18.4	1.8	18.1	130
R134a	15.9	1.6	15.6	14.2	1.4	13.9	130
R600a	7.8	0.8	7.7	6.9	0.7	6.7	120
R407C	24.8	2.4	24.3	21.9	2.1	21.5	130
R404A	28.3	2.8	27.7	25.2	2.5	24.7	130
R507A	29.0	2.8	28.5	25.9	2.5	25.4	130
R422D	24.6	2.4	24.1	21.8	2.1	21.4	130
R170	20.5	2.0	20.1	17.9	1.8	17.6	130
R508B	24.2	2.4	23.8	21.0	2.1	20.6	130

Note:

- Stated condition at condensing temperature 55°C. Maximum peak at condensing temperature 60°C
- Stated condition at condensing temperature -10°C. Maximum peak at condensing temperature -5°C for ULT



Do not use the compressor for pressurizing the system to check the pressostat limits.

The high-pressure and low pressure cut-out eventually used should have a manual reset feature for the highest level of system protection.



Ensure that the discharge gas temperature is always higher than the saturation temperature (including during compressor start after long stop and defrost).

11.5 SUCTION GAS OVERHEATING



Ensure a proper suction gas overheating, to avoid return of liquid to the compressor at any working conditions (min. 5 K with HFCs). This limit is valid also for HCs on systems with refrigerant charge up to 150 g, For systems with higher refrigerant charge, contact Embraco Technical support team.

In case a capillary tube is used, for the definition of the heat exchanger length for a proper suction gas overheating (and proper liquid subcooling) a length of 0.9 to 1.3 m can be adopted as a preliminary reference. Definitive heat exchanger length can be defined only after system testing.

11.6 COMPRESSOR OPERATING FIELDS

The system should be designed in order to assure that the compressor operate within the limits of evaporating and condensing temperatures defined in the *Figure 11.6.1*, by the green area (k), at indicated conditions of ambient and return gas temperature.



The red area (m) is acceptable only during transient periods.



Avoid to operate the compressor outside its approved limits. The consequent abnormal working conditions (high pressure, high temperatures, overload) can early damage the compressor.

Outside these approved limits, the system causes the compressor to operate at abnormal conditions (high pressures, high temperatures and overload) and can lead to early damages to the compressor.

The compressor damaged by applications operating outside the prescribed limits will not be considered under warranty.

11.6.1 COMPRESSORS ADMITTED OPERATING FIELDS

The working fields represented in this section are valid for all models and series of compressors for the correspondent application and refrigerant used.

LEGEND			
Tc	Condensing Temperature	k	Ambient 32°C and return gas 20°C
Te	Evaporating Temperature	m	Ambient 32°C and return gas 20°C (for transitory period)

Figure 11.6.1 Compressor approved operating fields

LBP
R134a - R600a

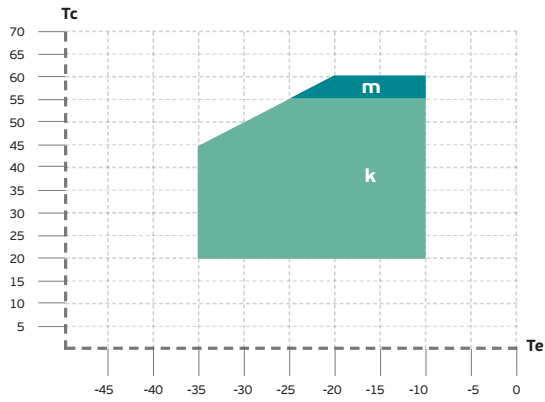

LBP
R404A/R507A/R452A - R290

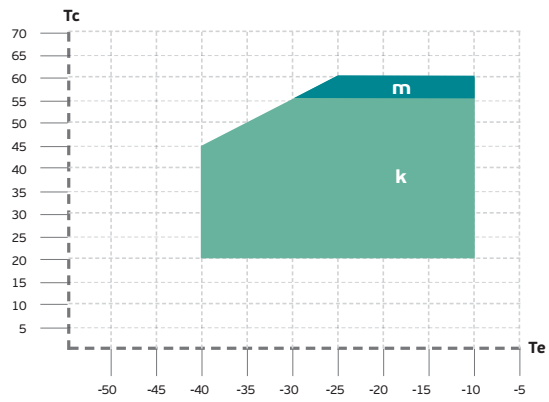

L/MBP
R290, R600a, R134a

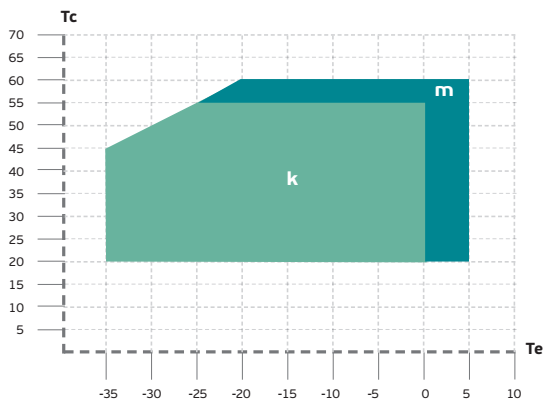

ULBP
R508B/R170 - second stage of cascade

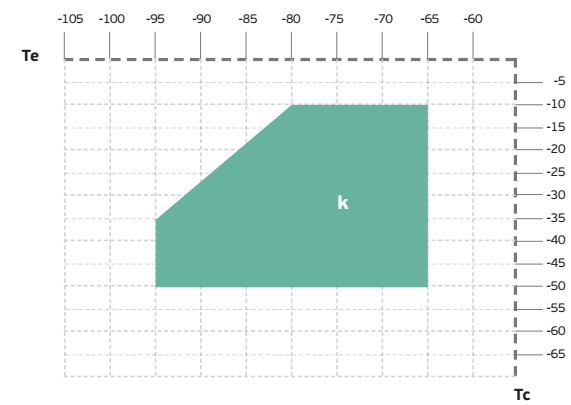

Note ULBP: Ambient temperature 32°C, return gas 0°C

MBP
R404A/R507A/R452A - R290

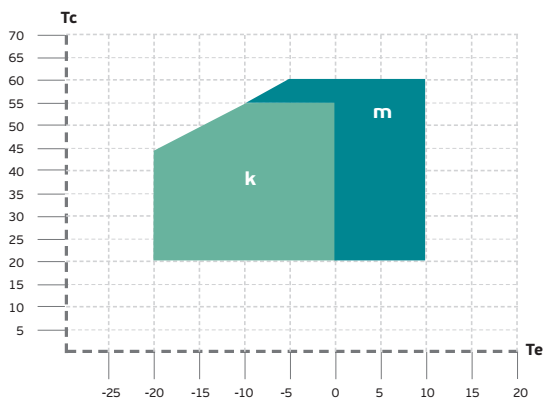

HBP
R134a - R600a

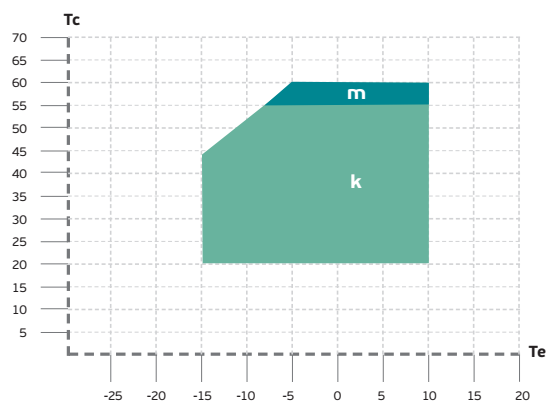

AC - R407C

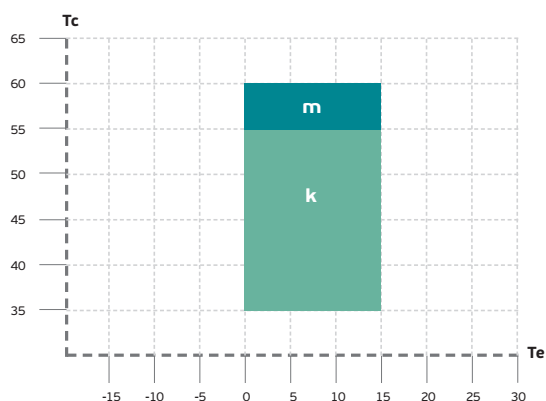

Many compressor models are released for condensing temperature down to 20 °C, or 10 °C. For details please contact Embraco Technical Support.

Note: Operating envelopes were modified comparing to latest Installation Instructions or Catalog edition. For details contact Technical support team.

- Operation Condition
- Transient Condition
- Tc** Condensing Temperature °C
- k** Ambient 32°C and return gas 20°C
- Te** Evaporating Temperature °C
- m** Ambient 32°C and return gas 20°C (for transitory period)

11.6.2 START CONDITIONS

The **Table 11.6.2** indicates temperature conditions corresponding to balanced and unbalanced pressures limits at which the compressor can start for voltages greater than or equal to 85% of rated voltage (see also **Table 4.4**).



For applications where the temperature and voltage are outside the indicated limits, compressor start is not guaranteed.

Table 11.6.2 *Temperature conditions corresponding to balanced and unbalanced pressures*

Application	Balanced pressure conditions LST+HST (°C)		Unbalanced pressure conditions HST (°C)	
	Discharge	Suction	Discharge	Suction
ULBP	22	22	55	-6.67
LBP	22	22	55	-6.67
MBP	27	27	55	8
L/MBP	27	27	55	8
M/HBP	27	27	55	8
HBP	30	30	55	8
AC	30	30	N/A	N/A

11.6.2.1 NOTES ON STARTING PRESSURES

HST models:

the suction starting pressures corresponding to the temperatures of the Table 11.6.2 represent the upper admitted suction limits for starting at unbalanced conditions at the discharge pressure temperature there indicated.

In case the system has higher suction pressure at the starting:

- a) the compressor may not start
- b) in case of start, due to the high suction pressure, the OLP may trip, the compressor may stall and the starting relay cycles repetitively on/off with motor and/or starting capacitor burn out (see case of OLP not operating in Chapter 10.1.6)

HST and LST models:

after starting at balanced pressure for the LST (and unbalanced or balanced for the HST), while the discharge pressure is increasing up, must be ensured that the suction pressure decreases quickly enough to avoid excessive load to the electric motor. If the suction pressure remains high the consequences are the same of case b).

The electrical supplier companies shall provide voltage to the users within the limits admitted by the local regulations. Check that these limits comply with the compressor characteristics.

Voltage drop of the supply line from the electrical plug to the compressor, both at starting and running conditions should be low enough to ensure that the voltage at the compressor pins is within the admitted limits of Table 4.4.

Startability limits vary with winding temperature. Higher winding temperature will reduce the pressures under which compressor is able to start.

11.6.3 USE OF TRANSFORMER TO RAISE THE VOLTAGE

The sizing of the this transformer needs careful consideration of the compressor LRA and of the max running current of the application, otherwise it may damage the compressor instead of improving its operation.

The transformer shall ensure that:

- With the LRA at the starting, the compressors pins receive at least the minimum starting voltage listed in Table 4.4 for various compressor motors.
- At the compressor max running condition, does not overheat and generate voltage drop out of the limits of the above table.
- Does not raise the voltage over the limits admitted by the compressor (see Table 4.4), when the supply line voltage reaches the max value.



As reference, the transformer capacity should be at least 2.5 times the compressor rated VA and should be designed for startability of hermetic compressor (motors having LRA even more than 10 times the FLA). When ordering a transformer, inform the producer/dealer on the above characteristics.

Contact the Embraco Technical support team in case of need of technical support.

11.6.4 COMPRESSOR CYCLING (ON-OFF)



System normal cycling are 4-6 cycles per hour, with sufficient run time to ensure the proper return of the oil to the compressor(*) and sufficient stop time for balancing the pressure before restart (in case a LST compressor is used).

(*) Effect of short on-cycle:

Compressor pumps oil in the system (small weight percentage of the pumped refrigerant) during running. At compressor starting oil may be pumped in higher amount: after each start the compressor has to run for a time (depending on system design) long enough to assure the oil returns to the compressor. Contact Embraco Technical support team if more info are needed.



Significant increase of cycling may result in early damage of starting device (especially electromechanical relays) or starting capacitors if incorporated and of compressor internal mounting springs and discharge loop.

Compressors with PTC starting devices must be re-started after a minimum time of 5 minutes from their off cycle in order to allow a temperature reduction sufficient to reset its conductivity.



The thermostat or other on-off controllers shall allow an adequate running time of the compressor. Normally in a well design system, on-cycles of 5-7 minutes after starting are sufficient for the oil returning to the compressor.



The trip of OLP (thermal/current protector of the compressor) requires that the compressor re-start occurs after the necessary time for the protector to reset (this may require even more than 1 h for internal OLP).

11.6.5 RUNNING TIME

Systems should be sized for max 80% of normal running time.

Running time of 100%, may be accepted under heavy load and high ambient temperature conditions. The systems should be tested in order to assure that even if working at 100% while simulating the worse conditions expected in the field, the compressor works within its approved operating limits of *Table 11.4*, *Figure 11.6.1* and *Table 11.6.2*.

11.6.6 HOT GAS DEFROST

Hot gas defrost (HGD) systems perform a faster and effective defrost compared to electric defrost systems, with a remarkable energy saving. However it presents stressing conditions to the compressor.

(*) Effect of short on-cycle:



Systems must be designed in order to avoid liquid back to the compressor and abnormal working conditions, ensuring operation during HGD with a max suction pressure equivalent to a saturation temperature of 7°C and a max discharge pressure equivalent to the saturated temperature of 35°C. These limits apply to all the types of refrigerants prescribed for the various Embraco models.

The cabinet must be checked under the more severe expected working conditions, at the minimum admitted supply voltage, to verify the respect of the above suction and discharge pressure. In case these limits are overpassed, inconvenient like the **Note 11.6.2.1** may happen.

In case of need, contact the Embraco Technical support team.

12. COMPRESSOR CONTROL PROCEDURES

The technicians who maintain or open the circuit of a refrigeration system should be properly trained, experienced and certified by a recognized certification body according to the applicable legislations. Those technicians should operate only in adherence with the instructions of the manufacture of the finished equipment and with all the applicable regulations and standards.

Before beginning to check the compressor:



For the compressor connection to the electrical supply line and for maintenance/repairing operation, refer also to Appendix 1- Recommendations - safety instruction for compressor installation



Disconnect the electrical power (check that the contactors are open) before removing the compressor terminal cover.



Do not replace a burnt fuse (or switch-on an open cut-off relay) without first checking for a short circuit. The intervention of these devices shows that short circuit is present or occurred.



NEVER try to switch on a GFCI (Ground Failure Circuit Interrupter) or RCD (Residual Current Device), according to country technical requirements, after it tripped; it is an evidence that a short circuit to ground is present or occurred. It is mandatory first to evaluate and eliminate the causes of the short circuit to ground.



NEVER switch-on compressors having an electrical short circuit or current leakage to ground (short circuit to ground); it may damage the compressor pin terminal insulation and cause refrigerant leakage, ignition sparks and fire. In case compressors presents the short circuit or leakage to ground, replace it, avoiding to connect it to the electrical supply line. To check for a short circuit to ground use a megohmmeter or a Hi-Potential Ground Tester (follow the producer's instructions for their safety use); with a normal ohmmeter it is not possible in certain conditions to detect a short circuit to ground.



Before supply power to the compressor, ensure that the compressor is properly connected to ground and the compressor terminal cover is firmly fastened. Eventual electrical measurement during the compressor running must be carried out in other points of the electrical circuit (see **Note 10.10.1**).



Do not supply power to a compressor that has motor failure (short circuit on wiring, short circuit to ground). This can generate a significant enough shock which can result in death. The high electrical current due to the short circuit may suddenly overheat the compressor pins and crack the glass insulation, with possible fire ignition (see Chapter **6.1.1**).

12.1 TROUBLESHOOTING AND SERVICE CHART

The operational failures effecting the compressors that may happen to the refrigeration system, can be, in most cases, identified and eliminated by consulting *Table 12.1*.

This Troubleshooting Chart is not comprehensive and does not intend to replace the instruction provided by the producer of the refrigeration system.

The listed failures in *Table 12.1* are among the most common to be found in established applications. For other possible defects which do not appear in the list or for running problems in the design phase of the applications, contact Embraco Technical support team.

It is recommended (before verifying the cabinet working conditions, analyze the deviation from normal conditions and define the problem route causes), to start from a check list like:

- Visual check of the electric boards, wiring, fuses etc.
- Check that the compressor electrical components are the ones specified by _ Embraco.
- Check their assembly compared with the electrical corresponding diagram as indicated in Chapter **6.1** or the compressor.
- Check setting and proper operation of all safety and protection devices.
- Check pressure and other switches, if installed.
- Check that all valves (eventually installed) are in the correct position for the running conditions.
- Check the system for leaks, starting from the most critical points.

Table 12.1 Troubleshooting and service chart

PROBLEM		POSSIBLE CAUSE		REPAIR
1	Compressor does not start - No hum	1.1	Line disconnected. Starting relay does not pick-up.	Check the line and starting relay.
		1.2	Fuse removed or blown.	Check the root case and solve the problem - replace the fuse.
		1.3	Overload protector tripping.	Check the electrical connections.
		1.4	Pressure-switch stuck in open position.	Replace the pressure-switch.
		1.5	Thermostat not correctly adjusted.	Reset or replace the thermostat.
		1.6	Electrical connections improper or loose.	Check wiring against diagram, or tighten the connections.
2	Compressor does not start (hums) but trip on the overload protector	2.1	Improperly connected.	Check wiring against diagram. Arrange the electrical connections according to the electrical diagram.
		2.2	Low voltage at the compressor.	Determine reason and correct.
		2.3	Start capacitor defective.	Determine reason and replace the capacitor if necessary.
		2.4	Starting relay failing to close.	Determine reason and correct, replace the relay if necessary.
		2.5	Compressor motor has a winding open or shorted.	Replace the compressor.
		2.6	Internal mechanical problem in compressor.	Replace the compressor.
3	Compressor starts, but does not switch off start winding	3.1	Improperly connected.	Check wiring against diagram.
		3.2	Low voltage at the compressor.	Determine reason and correct.
		3.3	Run capacitor defective.	Determine reason and replace.
		3.4	Starting relay failing to open.	Determine reason and correct, replace if necessary.
		3.5	Excessively high discharge pressure/suction pressure.	Check discharge shut-off valve, possible overcharge, excessive heat load, insufficient cooling at condenser.
		3.6	Compressor motor has a winding open or shorted.	Replace the compressor.
		3.7	Internal mechanical problem in compressor (tight).	Replace the compressor.
4	Compressor starts and runs, but short cycles on overload protector.	4.1	Additional current passing through overload protector.	Check wiring diagram. Check for added fan motors, pump, etc, connected to the wrong side of protector.
		4.2	Low voltage at compressor (or unbalanced if three phase).	Determine reason and correct.
		4.3	Overload protector defective.	Check current, replace protector.
		4.4	Run capacitor defective.	Determine reason and replace.
		4.5	Excessively high discharge pressure.	Check ventilation, restrictions in cooling medium, medium, restriction in refrigeration system.
		4.6	Excessively high suction pressure.	Check for possibility of incorrect application. Use stronger unit.
		4.7	Compressor too hot. Return gas hot.	Check refrigerant charge, check and repair eventual leaks; add gas if necessary.
		4.8	Compressor motor has a windings shorted.	Replace the compressor.

CONTINUE...

...FOLLOW

PROBLEM		POSSIBLE CAUSE		REPAIR
5	Unit runs OK but short cycles on	5.1	Overload protector.	See section 4.
		5.2	Thermostat.	Differential set too close. Widen.
		5.3	High pressure cut-out due to insufficient air or water supply.	Check and correct air or water supply to condenser.
		5.4	High pressure cut-out due to gas overcharge.	Reduce the refrigerant charge.
		5.5	High pressure cut-out due to air in the system.	Repeat vacuum and refrigerant charge.
		5.6	Low pressure cut-out due to liquid line solenoid leaking.	Replace solenoid valve.
		5.7	Low pressure cut-out due to insufficient refrigerant charge.	Repair leak and add refrigerant.
		5.8	Low pressure cut-out due to restriction in expansion valve.	Replace the expansion valve.
6	Unit operates long or continuously	6.1	Low refrigerant charge.	Repair leak and add charge.
		6.2	Refrigerated space has excessive load or poor insulation.	Determine fault and correct.
		6.3	System inadequate to handle load.	Replace with larger system.
		6.4	Evaporator coil iced.	Check defrost operation; eventually repair it.
		6.5	Restriction in refrigeration system.	Determine location and remove.
		6.6	Dirty condenser.	Clean condenser.
7	Start capacitor open, shorted or blown	7.1	Prolonged operation of the start relay due to low voltage to unit.	Determine reason and correct.
		7.2	Prolonged operation of the start relay due to improperly relay.	Replace the starting relay.
		7.3	Prolonged operation on start cycle due to starting load too high.	Determine reasons and correct them; use pump down arrangement if necessary.
		7.4	Excessive repeated short cycling.	Determine reason for short cycling (see section 5) and correct.
		7.5	Improper start capacitor.	Determine correct size and replace.
8	Run capacitor open, shorted, blown	8.1	Improper run capacitor.	Determine correct model and replace.
		8.2	Excessively high line voltage (out of the allowable limit)	Determine reason and correct.

CONTINUE...

...FOLLOW

PROBLEM		POSSIBLE CAUSE		REPAIR
9	Relay defective or burned out	9.1	Incorrect starting relay.	Check and replace.
		9.2	Incorrect mounting angle.	Remount relay in correct position.
		9.3	Line voltage too high or too low.	Determine reason and correct.
		9.4	Excessive short cycle.	Determine reason (see section 5) and correct.
		9.5	Relay being influenced by loose mounting, vibration	Remount the relay tightly; check for excessive vibrations and eliminate them.
		9.6	Incorrect run capacitor.	Replace with proper capacitor.
10	Refrigerated space temperatures too high	10.1	Control setting too high.	Reset control.
		10.2	Expansion valve too small.	Use a larger valve.
		10.3	Cooling coils too small.	Add surface or replace.
		10.4	Inadequate air circulation.	Improve air movement.
11	Suction line frosted or sweating	11.1	Expansion valve passing excess refrigerant or oversized.	Readjust valve or replace with smaller valve.
		11.2	Expansion valve stuck open.	Clean valve of foreign particles, replace if necessary.
		11.3	Evaporator fan-motor not running.	Determine reason and correct.
		11.4	Overcharge of refrigerant.	Correct charge.
12	Liquid line frosted or sweating	12.1	Restriction in drier or strainer.	Replace part.
		12.2	Liquid shut-off (main valve) partially closed.	Open valve fully.
13	Unit noisy	13.1	Loose parts or mountings.	Locate and tighten.
		13.2	Rubber grommets mounted without sleeves or incorrectly assembled.	Add the sleeves or mount correctly.
		13.3	Tubing rattle	Reposition/change loops to be free of contact.
		13.4	Bent fan blade causing vibration.	Replace fan.
		13.5	Fan motor bearing worn.	Replace fan-motor.
		13.6	Tubes joint incorrect (gas noise)	Reconnect joint correctly.

13. ELECTRIC CIRCUITS CONTROL

The electric tests, described in this chapter, allow determining the causes of possible anomalies or defects of electric components, electric motor and wiring for each type of electric motor. In case the problems appear during the final testing of the refrigerating application, before starting the check procedures, it is better to be sure that the connections are correct according to the electric wiring diagrams stated in Chapter 6.

To carry out the check, it is necessary to use suitable instruments for checking the continuity and for measuring the ohmic resistance, respecting the indicated sequence and referring to the electric diagrams (see Chapter 6).

Consider that the continuous lines represent the leads belonging to the electric component, or to the supplied wiring, while the dashed lines represent the suggested connection leads pertaining to the customer.

During operation in the field, the system can encounter some factors worsening the working conditions, such the reduction of the effectiveness on the condenser due to clogging, partial leakage of the refrigerant, fan motor failures, etc.

Because of these factors, it is recommend to size the system with a good margin and test it under the more severe conditions (normal and abnormal) expected in the field, to ensure that the system will operate within the prescribed limits of Chapter 11 and in safety conditions.



Wiring carried out differently from the ones indicated in Chapter 6, may required a different check procedure and measurement as indicated one

13.1.1 VERSION RSIR - RSCR WITH PTC STARTING DEVICE

Valid for EM/NE series

SM00 RSIR PTC starting device

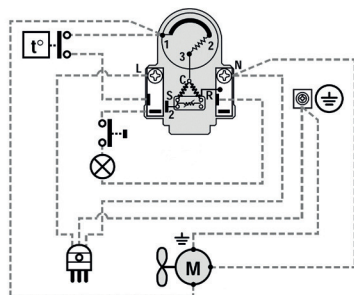

SM01 RSCR PTC starting device

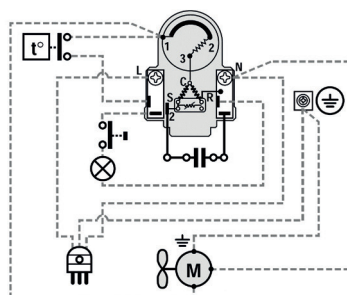

Verify with voltmeter the presence of the correct voltage on the "L" and "N" terminals of PTC starting device. If there is insufficient voltage, the thermostat is defective due to open contacts, connections, or an interruption in the cables.

Disconnect the other electrical components if present (motor fan, motor, etc), disconnect the voltage to the circuit at the supply line and carry out the following operations and checks:

1. Check the continuity on the terminal "3" of the overload protector. If continuity lacks, the thermostat must be replaced due to open contacts.
2. Take off the PTC starting device from the hermetic terminal.
3. If there is a run capacitor (RSCR version) disconnects it.
4. Take off the protector from the PTC starting device and check between points 1 and 3. If there is no continuity, be sure that the protector has no open contacts due to its trip. In this case, repeat the check after 10 minutes. Otherwise, the protector is defective due to open contacts.
5. Check the electric motor according to the procedure described in Chapter **13.2.1**.
6. Check the ohmic resistance of the stator run and start windings according to the procedure described in Chapter **13.2.2**.
7. On the PTC starting device check between the two fastons N and 2 the ohmic resistance of the PTC pill which must be $8 \div 16$ ohm for the 230V models and $2 \div 4$ ohm for the 115V model, at the ambient temperature of 25°C.



The ohmic resistance values measured with a normal tester can be out of the indicated by as much as 25% ÷ 30%.

8. If there is a run capacitor (RSCR version), check it according to the procedure described in Chapter **13.2.3**.

If problem was not observed based on above checks, there is no capillary clogging and the system does not run correctly yet, replace the compressor

13.1.2 VERSION RSCR WITH TSD STARTING DEVICE

Valid for EM series

SM02 RSCR TSD starting device

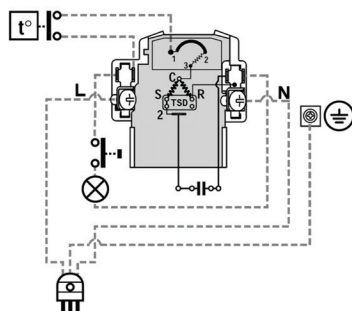

Verify with voltmeter the presence of the correct voltage on the terminal "1" on OLP and "N" terminal on TSD starting device. If there is insufficient voltage, the thermostat is defective due to open contacts, connections, or an interruption in the cables.

Disconnect the other electrical components if present (motor fan, motor, etc), disconnect the voltage to the circuit at the supply line and carry out the following operations and checks:

1. Check the continuity on the terminal "3" of the overload protector. If continuity lacks, the thermostat must be replaced due to open contacts.
2. Check the electric motor according to the procedure described in Chapter **13.2.1**.
3. Check the ohmic resistance of the stator run and start windings according to the procedure described in Chapter 13.2.2.
4. Take off the protector from the TSD starting device and check between points "1" and "3". If there is no continuity, be sure that the protector has no open contacts due to its trip. In this case, repeat the check after 10 minutes. Otherwise, the protector is defective due to open contacts.
5. Check run capacitor according to the procedure described in Chapter **13.2.3**.
6. Connect V-meter to terminals "L" and "N". Try to start compressor. Voltage across "2-N" terminals should drop close to 0V for period of 300-600ms. If there is not voltage drop there is probably failure of TSD electronics. Voltage drop is possible to observe with good resolution digital V-meter or eventually galvanic V-meter. TSD is timing starting device which connects starting winding for 300-600ms and during this time the voltage across "2-N" terminals drops close to 0V. This happens immediately after closure of thermostat contacts.

If problem was not observed based on above checks, there is no capillary clogging and the system does not run correctly yet, replace the compressor.



Check of # 6 requires skilled electrician with adequate education to avoid electric shock hazard.

13.1.3 VERSION RSIR WITH TERMINAL BOARD AND CURRENT RELAY STARTING DEVICE

Valid for EM/NE series

SM03 RSIR Terminal board and current relay starting device

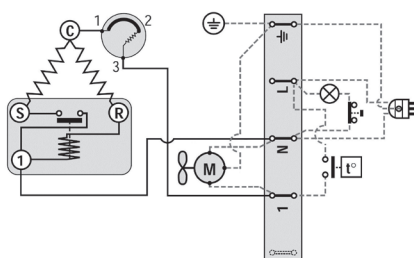

Verify with voltmeter the presence of the correct voltage on the "1" and "N" terminals of terminal board. If there is insufficient voltage, the thermostat is defective due to open contacts, connections, or an interruption in the cables.

Disconnect the other electrical components if present (motor fan, motor, etc), disconnect the voltage to the circuit at the supply line and carry out the following operations and checks:

1. Remove the terminal board, take off the starting relay and disconnect the protector cable from the hermetic terminal.
2. Check the continuity between the points "1" on the protector and "1" on the terminal board. If there is no continuity, the protector can be:
 - a) faulty due to open contacts
 - b) tripped; then repeat the check after 10 minutes
 - c) not connected to the terminal board.
3. Keep the start relay in the same vertical position as assembled on the hermetic terminal (do not incline or overturn).
4. Check continuity between terminals "N" on the terminal board and "S" on the relay. If there is continuity the relay is defective due to closed contacts.
5. Check continuity between terminals "N" on the terminal board and "R" of relay. If there is no continuity, the defect can be due to:
 - a) relay with open coil
 - b) relay not connected to the terminal board.
6. Check the electric motor according to the procedure described in Chapter **13.2.1**.
7. Check the ohmic resistance of the stator run and start winding according to the procedure described in Chapter **13.2.2**.

If from all above checks a problem was not found, there is no capillary clogging and the system does not yet run correctly. Replace starting relay, excluding possible faults of contacts opening and closing (pick-up and drop-out currents) that can not be determined with above checks.

If compressor does not yet run correctly, it must be replaced due to internal defects.

13.1.4 VERSION CSIR AMERICAN VERSION AND CURRENT RELAY STARTING DEVICE

Valid for NE/NT series

SM04/SM20 CSIR American version and current relay starting device

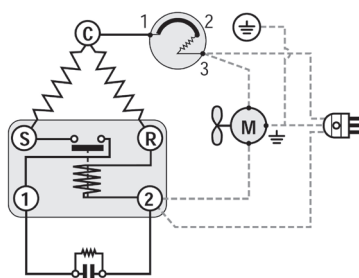

Starting relay contacts are normally open.

Verify with voltmeter the presence of the correct voltage on the terminals "2" of relay and "3" of protector. If there is insufficient voltage, the thermostat is defective due to open contacts, connections, or there is an interruption in the cables. Disconnect the other electric components if present (motor fan, motor, etc), disconnect the voltage to the circuit at the supply line and carry out the following operations and checks:

1. Check the continuity between the points "1" and "3" of the protector. If continuity lacks, be sure that the protector has no open contacts due to its trip. In this case repeat the check after 10 minutes.
2. Take off the start relay from the hermetic terminal and keep it in the same vertical position (do not incline or overturn).
3. Check continuity between terminals "1" and "S" on the relay. If there is continuity the relay is faulty due to closed contacts.
4. Check continuity between terminals "2" and "R" of relay. If there is no continuity the relay coil is open.
5. Check the electric motor according to the procedure described in Chapter **13.2.1**.
6. Check the ohmic resistance of stator run and start windings according to the procedure described in Chapter **13.2.2**.
7. Check the start capacitor according to the procedure indicated in Chapter **13.2.3**.

If from all above checks a problem was not found, there is no clogging in the expansion device and the system does not yet run correctly. Replace starting relay, excluding possible faults of contacts opening and closing (pick-up and drop-out currents) that can not be determined with above checks.

If compressor does not yet run correctly, it must be replaced due to internal defects.

13.1.5 VERSION CSIR TERMINAL BOARD AND CURRENT RELAY STARTING DEVICE

Valid for EM/NE/NT series

SM05/SM19 CSIR Terminal board and current relay starting device

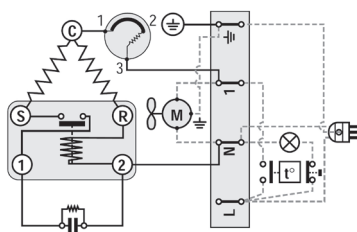

Starting relay contacts are normally open.

Disconnect the other electrical components if present (motor fan, motor, etc), disconnect the voltage to the circuit at the supply line and carry out the following operations and checks:

1. Remove the terminal board, take off the starting relay and disconnect the protector cable from the hermetic terminal.
2. Check the continuity between the points "1" of protector and "1" of terminal board. If there is no continuity, the protector can be:
 - a) faulty due to open contacts
 - b) tripped; then repeat the check after 10 minutes
 - c) not connected to the terminal board.
3. Keep the start relay in the same vertical position as assembled on the hermetic terminal (do not incline or overturn).
4. Check continuity between terminals "N" on the terminal board and "R" on the relay. If there is no continuity the defect can be due to:
 - a) relay with coil breaking
 - b) relay not connected to the terminal board.
5. Check continuity between terminals "1" and "S" of relay. If there is continuity, the relay is faulty due to closed contacts.
6. Check the electric motor according to the procedure described in Chapter 13.2.1.
7. Check the ohmic resistance of the stator run and start winding according to the procedure described in Chapter 13.2.2.
8. Check starting capacitor according to the procedure indicated in Chapter 13.2.3.

If from all above checks a problem was not found, there is no clogging in the expansion device and the system does not yet run correctly. Replace starting relay, excluding possible faults of contacts opening and closing (pick-up and drop-out currents) that can not be determined with above checks.

If compressor does not yet run correctly, it must be replaced due to internal defects.

13.1.6 VERSION CSR/CSIR BOX WITH EXTERNAL OVERLOAD PROTECTOR

Valid for NE/NT/NJ series

SM06/SM17/SM21/SM23/SM24 CSR/CSIR box with external overload protector

CSR version

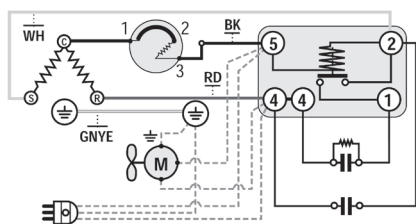

CSIR version

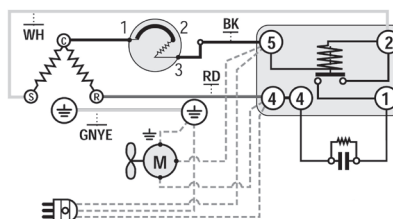

Verify with voltmeter the presence of the correct voltage on the terminals "4" and "5" of starting relay. If there is insufficient voltage, the thermostat is faulty due to open contacts, connections, or there is an interruption in the cables.

Disconnect the other electric components if present (motor fan, motor, etc), interrupt the voltage to the circuit disconnecting it from supply line and carry out the following operations and checks:

1. Disconnect all the connections on terminals "2" and "5" of the starting relay.
2. Check the continuity between terminals "2" and "5" of the starting relay. If there is no continuity, there is a broken coil and the relay must be replaced.
3. Check the continuity between terminals "1" and "2" of starting relay. If there is no continuity, the contact is open and the relay must be replaced.
4. If there is an external overload protector, check, according to the type, the continuity between terminals "1" and "3" or "1" and "2". If there is no continuity, the protector can be faulty or there could have been a trip, so repeat the check after 10 minutes.
5. Check the electric motor according to the procedure described in Chapter **13.2.1**.
6. Check the ohmic resistance of the stator run and start windings according to the procedure described in Chapter **13.2.2**.
7. Disconnect one of the two cables of the starting capacitor.
8. Check the start and run (not in case of CSIR) capacitors according to the procedure described in Chapter **13.2.3**.
9. Check the continuity of the cables disconnected from the "2" and "5" terminals of the starting relay.

If from all above checks a problem was not found, there is no clogging in the expansion device and the system does not yet run correctly. Replace starting relay, excluding possible mistakes of opening and closing of the contact (pick-up and drop-out currents) that can not be determined with above checks.

If compressor does not yet run correctly, it must be replaced due to internal defects.

13.1.7 VERSION CSR/CSIR BOX WITH INTERNAL OVERLOAD PROTECTOR

Valid for NE/NT/NJ series

SM10/SM13/SM16/SM26 CSR/CSIR box with internal overload protector

CSR version

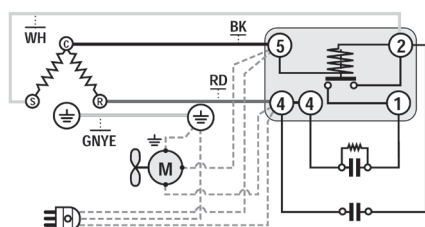

CSIR version

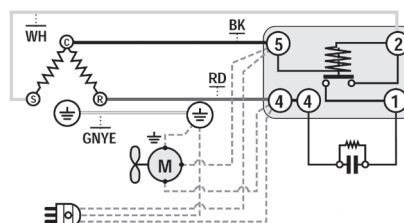

Verify with voltmeter the presence of the correct voltage on the terminals "4" and "5" of the starting relay. If there is insufficient voltage, the thermostat is faulty due to open contacts, connections, or there is an interruption in the cables.

Disconnect the other electric components if present (motor fan, motor, etc), interrupt the voltage to the circuit disconnecting it from supply line and carry out the following operations and checks:

1. Disconnect all the connections on terminals "2" and "5" of the starting relay.
2. Check the continuity between terminals "2" and "5" of the starting relay. If there is no continuity, there is a broken coil and the relay must be replaced.
3. Check the continuity between terminals "1" and "2" of starting relay. If there is no continuity, the contact is open and the relay must be replaced.
4. There is an internal overload protector, check the continuity of motor run and start winding with ohmmeter directly on pins of hermetic terminal. Run winding resistance between "C-R" pins, and start winding resistance between "C-S" pins. If there is an infinite resistance on run or start winding the protector/winding can be faulty or there could have been a trip, so repeat the check after 1 hour.



Internal overload protector typically takes longer time to re-set than the external one.

5. Check the electric motor according to the procedure described in Chapter **13.2.1**.
6. Check the ohmic resistance of the stator run and start windings according to the procedure described in Chapter **13.2.2**.
7. Disconnect one of the two cables of the starting capacitor.
8. Check the start and run (not in case of CSIR) capacitors according to the procedure described in Chapter **13.2.3**.
9. Check the continuity of the cables disconnected from the "2" and "5" terminals of the starting relay.

If from all above checks a problem was not found, there is no clogging in the expansion device and the system does not yet run correctly replace starting relay, excluding possible mistakes of opening and closing of the contact (pick-up and drop-out voltages) that can not be determined with above checks.

If compressor does not yet run correctly, it must be replaced due to internal defects.

13.1.8 VERSION PSC WITH INTERNAL OR EXTERNAL OVERLOAD PROTECTOR

Valid for NJ series

SM12/SM15 PSC with internal or external overload protector

External OLP version

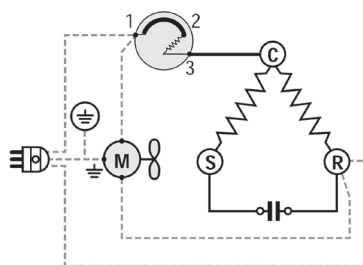

Internal OLP version

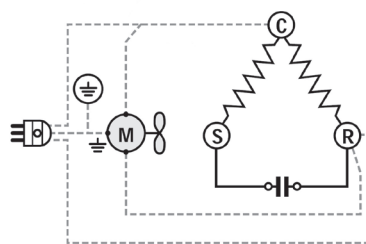

Verify with voltmeter the presence of the correct voltage on the terminals "R" and "C" of hermetic terminal (version with internal protector) or between "R" on hermetic terminal and "1" on external overload protector. If there is insufficient voltage, the thermostat is faulty due to open contacts or there is an interruption on the cables or on the connections.

Disconnect the other electric components if present (motor fan, motor, etc), interrupt the voltage to the circuit at the supply line, and carry out the following operations and checks:

1. If there is an external overload protector, check the continuity between points "1" and "3". If there is no continuity, the protector can be faulty, or can trip, so repeat the check after 10 minutes.
2. Check the electric motor according to the procedure described in Chapter **13.2.1**
3. Check the ohmic resistance of the stator run and start windings according to the procedure described in Chapter **13.2.2**
4. Check the run capacitor according to the procedure indicated in Chapter **13.2.3**.

If from all above checks problem was not found, there is no clogging in the expansion device, and the system does not yet run correctly, replace the compressor.

13.1.9 VERSION 3-PHASE INTERNAL OVERLOAD PROTECTOR

Valid for NJ series

SM18 3-phase internal overload protector

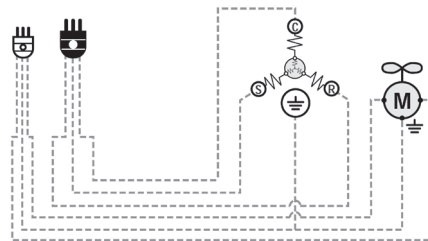

Verify with voltmeter the presence of the correct voltage of the three phases, on the three pins of the hermetic terminal. If there is insufficient voltage, check the presence of a break on the contacts of relay, cables and connections.

Disconnect the other electric components if present (motor fan, motor, etc), interrupt the voltage to the circuit at the supply line, and carry out the following operations and checks:

1. Check the continuity of the winding of the three phase electric motor, among the pins of the hermetic terminal (3 measures carried out between 2 pins at a time). The lack of continuity indicates an interruption in the electric motor winding.
2. Check the continuity among the three pins of the hermetic terminal and the ground plate on the compressor. If there is continuity, the electric motor has the windings shorted.
3. Check with a suitable instrument the ohmic resistance of the three phases of the stator windings, through the three pins of the hermetic terminal on the compressor.

The values of resistance indicated in Embraco Technical datasheet must result within the tolerance of $\pm 10\%$ at the ambient temperature of 25°C .



Note: Each of the three phases can have different ohmic resistance value.

If from all above checks problem was not found, there is no clogging in the expansion device, and the system does not yet run correctly, replace the compressor.

13.1.10 VERSION 3-PHASE INTERNAL + EXTERNAL OVERLOAD PROTECTOR

Valid for NT series

SM27 3-phase internal + external overload protector

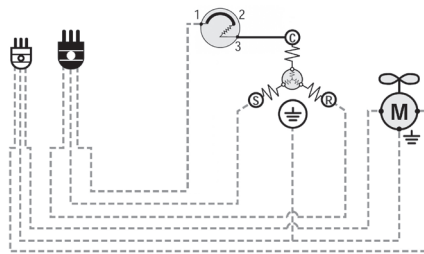

Verify with voltmeter the presence of the correct voltage of the three phases, on the 2 pins of the hermetic terminal and terminal 1 of the overload protector. If there is insufficient voltage, check the presence of a break on the contacts, cables and connections.

Disconnect the other electric components if present (motor fan, motor, etc), interrupt the voltage to the circuit at the supply line, and carry out the following operations and checks:

1. If there is an external overload protector, check the continuity between points "1" and "3". If there is no continuity, the protector can be faulty, or can trip, so repeat the check after 10 minutes.
2. Check the continuity of the winding of the three phase electric motor, among the pins of the hermetic terminal (3 measures carried out between 2 pins at a time). The lack of continuity indicates an interruption in the electric motor winding or opened internal overload protector. Repeat the test approximately after 1 hour to be sure overload protector had time enough to re-set.
3. Check the continuity among the three pins of the hermetic terminal and the ground plate on the compressor. If there is continuity there is short circuit to the ground.
4. Check with a suitable instrument the ohmic resistance of the three phases of the stator windings, through the three pins of the hermetic terminal on the compressor.

The values of resistance indicated in Embraco Technical datasheet must result within the tolerance of $\pm 10\%$ at the ambient temperature of 25°C.



Note: *Each of the three phases can have different ohmic resistance value.*

If from all above checks problem was not found, there is no clogging in the expansion device, and the system does not yet run correctly, replace the compressor.

13.2 CONTROL PROCEDURES

13.2.1 CONTROL OF ELECTRIC MOTOR (STATOR) WINDINGS

1. Check the continuity between the pins "C" and "S" of the hermetic terminal. If there is no continuity, there is an interruption in the electric motor start winding.
2. Check the continuity between the pins "C" and "R" of the hermetic terminal. If there is no continuity, there is an interruption in the electric motor run winding.
3. Check the continuity between the pin "C" of the hermetic terminal and the ground plate on the compressor. If there is continuity, the electric motor windings are shorted to ground.

13.2.2 CONTROL OF STATOR WINDINGS OHMIC RESISTANCE

1. Check with a suitable instrument the ohmic resistance of the start and run stator windings through the three pins of hermetic terminal on compressor.

The values of start winding resistance (measured on pins "C-S") and run winding resistance (measured on pins "C-R") indicated in the Embraco Technical Datasheet must be within the tolerance of $\pm 10\%$ at the ambient temperature of 25°C.

13.2.3 CONTROL OF START AND RUN CAPACITORS

1. Check the run and start capacitor on the two terminals using a capacitance meter.

14. COMPRESSOR REMOVAL AND REPLACEMENT

Statistics after analysis of returned compressors to Embraco indicate that the higher percentage (aprox 35 %) are without failures and have been disassembled by misunderstanding of the real problems on the refrigeration system.

The replacement of a compressor is an onerous task and requires an accurate diagnosis of the system before deciding to proceed with it.



Improper procedures to remove the failed compressor and install a new one, may cause injury to person, release of refrigerants and oil to the environment, fire and damages to propriety.



Avoid repairing and leaving unattended a system with:

- No refrigerant charge.
- Rotolock valve and other service valves closed.
- Holding OFDN charge used for pressurization or leakage test.

14.1 COMPRESSOR REMOVAL AND REPLACEMENT - HFCS MODELS



When repairing a refrigeration system, replacing a compressor and installing a new ones, follow all applicable international regulation and standards, (like EN 378-4 or similar), and the local ones, as well as the safety warnings and recommendations indicated in this Installation Instructions.

The transport of pressure vessels (like the ones containing refrigerants) are covered by international regulations, like the ADR (European Agreement concerning the International Carriage of Dangerous Goods by Road) and by local regulations that must be applied.

Storage and handling of vessel refrigerants shall be made in accordance with applicable regulations.

For recovery, reuse, recycling and reclamation of the refrigerant follow EN 378-4 or equivalent standards, as well as the applicable local regulations.

14.1.1 COMPRESSOR REMOVAL PROCEDURE



The compressor replacement must be carried out in properly ventilated ambient. Disconnect the system from the electrical power.

Ground the cabinet

- Check the conditions of the electrical wirings and connections, with special care to the ground wire; replace eventual damaged parts.
- Check the system for leakages with leak detector suitable for the refrigerant used on the system and having a sensitive of at less than 3 g/year.
- Remove the protective shield to access the compressor.
- Remove the compressor terminal covers and disconnect all the compressor electrical components.



Recover the entire refrigerant charge before removing the compressor (if the line tubes are cut when the system contains even fractions of the refrigerant charge, it will cause a rapid release of refrigerant mixed with oil, with pollution to the environment and possible injury due to inhalation of gas or frostbite).

To recover the refrigerant use a suitable recovery units and apparatus, follow the instruction of the producers and the applicable regulations.



The only acceptable practices on refrigerant removed from systems are recovery, reuse, recycling and reclamation. All the applicable standards and regulations for these operations must be followed.

Avoid to vent refrigerants in the ambient. In several countries there are legal obligation on technicians to prevent this uncorrect operation and to act minimizing leaks and repair systems with leaks as soon as possible..

To remove the refrigerant:

- Connect a hose to the service valve, if available on the system. Otherwise use a piercing valve (with a schrader connection) on the service tube, connect the hose (with schrader connection) to the recovery unit in order to start the refrigerant recovery procedure.
- Use a filter dryer at the entry of the recovery unit.
- Adhere the instructions of the recovery machine producer. Go down with recovery up to a residual pressure of 0.3 abs bar (make reference to EC 842 or equivalent applicable regulations).



Be careful not to exceed the maximum charge indicated on the recovery vessel for the specific refrigerant. Overcharges can lead to vessel explosion.

- Unsolder the line tube from the compressor.
- Remove the compressor from the cabinet base plate (see Chapter **15** for compressor disposal).
- In case the compressor has to be returned to Embraco, follow the instruction of Chapter **16**.
- Purge the system using OFDN only.

14.1.2 COMPRESSOR REPLACEMENT PROCEDURE



- Do not perform unnecessary tests before install or start a new compressor. All tests have been already carried out in the Embraco production lines and labs.
- Change the dryer, as the refrigeration system has been opened.
 - For the assembling of a new compressor and brazing, follow the procedure of Chapter **10.5**.
 - Brazing requires specific trained personnel and brazing procedure approvals.
 - Assemble the electrical components according to the wiring diagram of *Figure 6.1b*.
 - When replacing a compressor do not use the electrical components installed on the replaced compressor. Use new components supplied with the new compressor and check the correspondences with the ones prescribed for the specific compressor model as listed in the **Embraco Product catalogue** on www.embraco.com Connect the components with the care indicated in Chapter **6**.



- After assembly, the system shall be tested for leakages by pressurizing with OFDN. Pressure must be according to the applicable regulation and to the design pressure of the system components in order to avoid injuries and damages.
- When testing the low pressure side of the system, pressure to the compressor shell must not exceed 16 bar (see Chapters **10.6.1.3** and **7.6**).
- Release the OFDN and carry out vacuum, refrigerant charge and leak test (refer to the Chapters **10.6.1.3** - **10.6.1.5**, and **10.3.5** of this Installation Instructions for these operations).



In case the refrigerant has to be charged into the compressor, connect the charging line to the compressor process tube and allow the refrigerant entering at vapor state. When the refrigerant vapor reaches a pressure equivalent to the saturation pressure of 5 to 10°C, start the compressor and continue to charge the refrigerant at vapor state until the final charge is reached.

It is allowed to charge the system only with the refrigerant type (that must correspond with the refrigerant marked on the compressor label). and quantity indicated on the cabinet label.

When the charge procedure is finished, fix strongly the cap on the Schrader valve (or pierce strongly the service tube, cut the Schrader valve and close the tube by brazing (eventually use a lokring cap).

Fix properly the compressor terminal cover and ensure the compressor and the system is grounded before supply voltage.



After repairing, the system should be checked for leakages, use leak detector specific for the adopted refrigerant, with a sensitivity of less than 3 g/year and run for analyzing the performance and Watt/Amps input. For compressor, refer to the Technical datasheet in the **Embraco Product catalogue** on www.embraco.com For entire application refer to data that the cabinet manufactures should provide.

14.2 COMPRESSOR REMOVAL AND REPLACEMENT - R600a AND R290 MODELS



Only competent technicians trained on the safety use of flammable refrigerants are allowed to open refrigerant circuits or equipment housing of hydrocarbon systems.

International and National regulations and rules that apply to potential explosive atmospheres must be followed.

For repairing the system, technicians should follow the instructions issued by the finished product manufactures and all the applicable international and national regulations and standards, operating in order to prevent as much as possible the risk of flammable refrigerant leaking into the surrounding.

In addition to the instructions of Chapters **10.6.2** in case of use of flammable refrigerant, the following actions must be adopted.

14.2.1 PREVENTIVE ACTIONS TO BE ADOPTED

When possible, do not carry out repairs on site but only in workshops equipped to operate in security on systems with HCs refrigerant.

Due to the flammability of R600a and R290, the processing area of the cabinets containing these refrigerants should be intrinsically safe and with adequate forced ventilation.

- Before to start any activities, carry out a risk assessment of the entire operation.
- Avoid presence of flammable substances in the repairing area.
- Avoid presence of ignition sources at a distance according to applicable regulations (at least 3 m).
- Ensure the presence of fire extinguishers (powder or CO₂ type, their characteristics and location must be according to applicable local regulations).
- The working area must be monitored with a hydrocarbon detector suitable for potential explosive atmosphere (ATEX approved or similar approvals) with visible and audible alarm, located at low level (HCs are heavier than air), with sensitivity detecting lower than the 15% of the refrigerant LFL.
- The working area must be marked by warning and prohibition signs applicable to potential explosive atmosphere and according to the local regulation.
- There must be no tunnels, culverts, drains where the refrigerant may enter.
- Use only tools/apparatus suitable for potential explosive environments (i.e. vacuum pump, recovery machine, fan motors, etc, all granting ATEX or equivalent approvals).
- Keep a safety distance between the various repairing zones, in order to avoid dangerous situation in case of HC leakages (good practices suggest 3 m).
- Wear antistatic shoes and an antistatic-electricity tag.

14.2.2 FAILURE DIAGNOSIS

- Ground the cabinet to avoid electrostatic sparks.
- Remove the protective shield to access the compressor.
- Remove the compressor terminal cover.
- Check the electrical connection diagrams and the connections to the compressor, check the conformity of the compressor electrical components - protectors, relays, capacitors with what is prescribed by Embraco on the compressor Technical datasheets on the www.embraco.com
- Check the integrity of the cables and terminal retention (especially the ground wire). Eventually change and fix them properly.
- Visually analyze each system component: condenser, capillary tube, evaporator, fan motor, thermostat, etc., and the integrity of pipes, solders, etc.
- Check all the system for leakages, using a leak detector for the specific flammable refrigerants and suitable for potential explosive atmosphere (ATEX or similar approvals), sensitivity of less than 3 g/year, see Chapter **10.6.2.15**.
- Open the cabinet door(s) and blow air inside (in general blow air inside any confined part of the refrigeration machine) using blower suitable for potential explosive atmospheres (having ATEX or similar approvals).
- Before supplying energy to the system, blow air on the compressor and condenser zone using blower suitable for explosive atmosphere. If the leak (previously undetected) is on the high pressure side, it will be more pronounced while the compressor is running.
- Fix properly the compressor electrical cover and the protected shield of the cabinet.
- Supply energy to the cabinet (after ensuring that the compressor and the cabinet are properly grounded) checks again leakages on the high pressure side.
- Diagnose the failure causes.

14.2.3 COMPRESSOR REMOVAL

In case is necessary to replace the compressor:

- Disconnect the cabinet from the electrical supply line
- Ground the cabinet to avoid electrostatic sparks
- Remove the protective shield to access the compressor
- Remove all the compressor electrical components
- Fit a needle valve on the service tube
- Remove the refrigerant charge using a recovery machine and apparatus that fulfill the safety requirements of potential explosive atmosphere or vent the refrigerant charge in the atmosphere - in case the venting of HCs is admitted by local regulations for the quantity of refrigerant charged into the system - in an outside ambient that respects the safety conditions, away from heat and ignition sources (see *Figure 14.2.3a*) and limited by warning signs of danger. The recovery machine should be operated until a residual pressure of 0.3 bar (abs) is reached.

Figure 14.2.3a HCs refrigerant venting

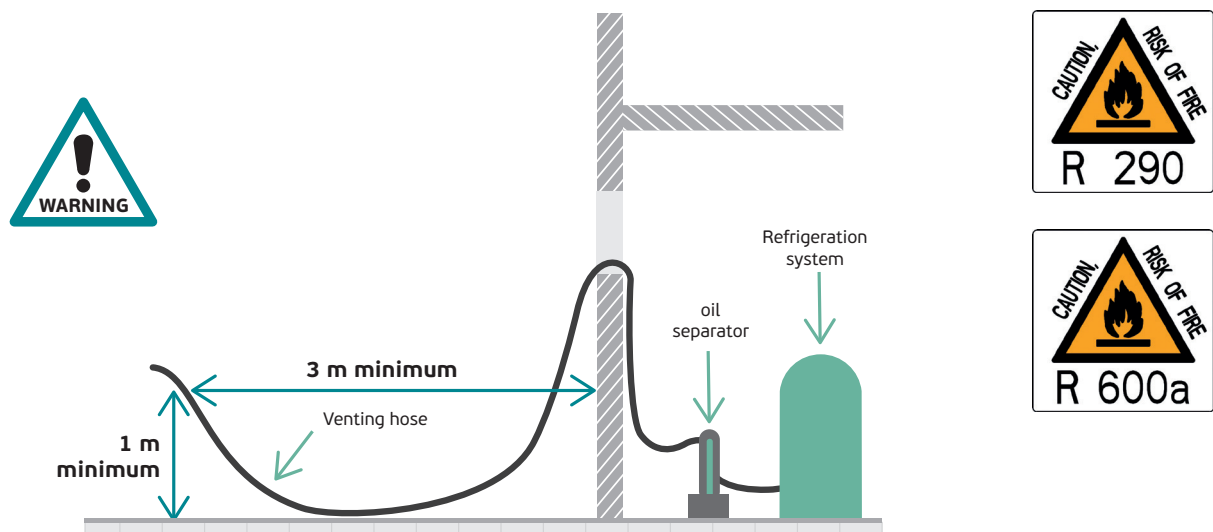

In case of recovery, use specific vessel suitable for HCs carrying proper marking.



Be careful not to exceed the maximum charge indicated on the recovery vessel for the specific refrigerant. Overcharges can lead to vessel explosion. Due to the different density of HCs vs HCFCs/HFCs refrigerants, it's possible to fill the same cylinder (same volume) with only 40% of HCs weight vs HCFCs/HFCs.



Remove the needle valve, cut - do not use flame - the tube and insert a Schrader valve (to get a larger port) or other connection (flare and nut or quick connection).

14.2.4 SYSTEM WASHING BY OFDN (OXYGEN-FREE-DRY-NITROGEN) PROCEDURE

- Make a first vacuum for at least 5 minutes.
- Fill the system using ofdn only, at max 6 bar pressure (this pressure will avoid damages to roll-bond evaporators eventually used) - first washing.
- Release the ofdn and make a second vacuum for 5 minutes.
- Fill the system with ofdn at max 6 bar - second washing.
- Release the OFDN.
- Cut the suction and discharge line tubes by using a cutter (do not use flame)
- Remove compressor from the cabinet within 15 minutes after system purging
- See Chapter 15 for compressor disposal or Chapter 16 if the compressor has to be returned to Embraco.



Do not reuse compressors disassembled from system containing flammable refrigerants. HC refrigerants remain mixed with the oil and may generate flame when attempt to braze the used compressor to the system.

14.2.5 INSTALLING A NEW COMPRESSOR

- Install new compressor on the cabinet base, see Chapter **10.8**.
- On the compressor's service tube braze additional tube (approx. 15 cm long) with a Schrader valve at its end, or use quick connections. If the system was arranged for a 2 sides vacuum, set up in the same way a second connection on the high pressure side.
- Braze the discharge and suction line tubes to the corresponding compressor tubes (for the brazing operation see Chapter **10.6.2.11**).
- Charge the system with OFDN to a pressure corresponding with the system design (see Chapter **7.6** for the max pressure inside the compressor shell).
- Check the tightness of the system.
- Release the OFDN.

14.2.6 SYSTEM VACUUM, CHARGING AND SEALING

- Carry out a vacuum. For the vacuum conditions and procedure see Chapter **10.6.2.12**.
- Pierce strongly the service tube of the high side (normally due to the small charge of HCs, the systems are charged through the compressor service tube) and cut with a cutter the Schrader valve (or remove the quick connection) of the service tube on the system high side.
- Drop a bead of sealant on the lokring cap and place by twisting it on the tube.
- Apply the jaws of the clamp on the cap and close the clamp strongly. The cap is properly secured if the two parts fit together perfectly.
- Charge the refrigerant through the compressor service tube and measure carefully(*) the amount of refrigerant filled in the system, in order to be sure to charge the same quantity originally charged by the cabinet producer, as specified on the cabinet label.

(*) Note: due to the small amount of the HCs refrigerant charge compared to equivalent HFCs, an accurate weighting of the HC charged in the system is mandatory to ensure proper performance and energy consumption of the repaired cabinet.

- Close the valve of the HC vessel immediately after finishing the charge procedure. If the vessel is a movable one, store it in the proper storing area for flammable refrigerants.
- Close the service tube with a lokring, proceeding as done with the second way vacuum tube.
- Install and connect the new electrical components of the compressor (check the correspondence with the prescribed components in the **Embraco Product catalogue** on www.embraco.com using only original spare parts with the care indicated on the **Chapter 6.1.1**).
- Check all the electrical connections to be sure they are properly connected, particularly check the continuity of the ground connection of the cabinet.
- Check leaks by using a leak detector for the specific flammable refrigerant and use only detector that have been manufactured and certified intrinsically safe (ATEX or similar approvals) for HCs (sensitivity of less than 3 g/year).

14.2.7 REPAIRED CABINET VERIFICATION

- Make sure that the compressor and the cabinet are properly grounded.
- Fix the protective cover on the compressor terminal.
- Fix the protective shield on the cabinet.
- Connect the cabinet to the electrical supply line and run it.
- Check again the high pressure side of the system for a leakage.
- Check the cabinet working conditions.



For the compressor connection to the electrical supply line and for maintenance/repairing operation, refer also to Appendix 1- Recommendations - safety instruction for compressor installation.

14.2.8 RETROFITTING

Embraco does not approve retrofitting.



Due to the specific safety aspects that must be consider when designing HCs equipments and their components versus the HCFCs and HFCs ones, Embraco does not approve the retrofitting with R600a and R290 of systems designed for other refrigerants.

15. COMPRESSOR DISPOSALS

Disposal of refrigerating systems, its parts and components shall be undertaken in accordance with the system producer's instructions and with national regulations.

For recovery, reuse, recycling and reclamation of the refrigerant follow EN 378-4 or similar standards, as well as the applicable local regulations.

Use the correct equipment and method for removal the compressor (see Chapter **14.1.1** for HFC model, or the applicable parts of Chapters **14.2.3** and **14.2.4** for HC model).

Drain out the oil from the compressor and treat it according to the applicable regulations.

Dispose the compressor according to applicable regulations.



The oil of the compressors disassembled from HC systems contains a certain amount of HC refrigerants. The oil must be drained out and the compressor tube sealed.

The compressors shall be stored in ambient properly ventilated.

Oil drained from used HC compressors must not be mixed with other oils and must be treated as a hazardous waste material according to the local applicable regulations.

When necessary, an expert in dealing with safe disposal of refrigerants and oils should be consulted.

16. HOW TO RETURN SUPPLIED PRODUCTS TO EMBRACO EUROPE

For the warranty on products supplied by Embraco, refer to what is indicated in the sales conditions.

The validity of the warranty (if applicable) is subject to the results of the analysis carried out in Embraco on the returned compressors. A technical report of the analysis will be send to the customer.

Customer may participate in the analysis.

The return (and delivery terms) of compressors to Embraco for technical analysis has to be agreed between Embraco Sales Department and the Customer. The delivery conditions and documents shall be according to the Embraco Sales Department instructions.

To ensure a timely analysis and the correct definition of the root causes of the problem, Embraco request to observe the following rules:



- Disassembly of the compressor from the system, following the instruction (see Chapter **14.1.1** for HFC model, or the applicable parts of Chapters **14.2.3** and **14.2.4** for HC model).
- Disconnect the supply wirings from the compressor terminals without remove the electrical components.
- Cut the line tubes at least 50 mm away from the compressor ports (do not unsolder) and close them with the specific rubber taps or by brazing if the compressor is a HFC model.
- Use taps if the compressor is a HC model only (in this case the oil still contains flammable refrigerants and can generate fire in case of brazing).
- Do not carry out potential destructive tests (i.e. Dielectric strength test) and do not remove the oil from the compressor.
- Do not abrade or eliminate the nameplate.
- Indicate on the compressor top with a marker (or on a adhesive label) the reasons of the replacement.

It is sufficient macro-indication like:

- noisy
- leakages on tube/shell (evidencing the leak point)
- does not start (specify in which conditions)
- does not cool the system
- OPL trips
- grounded
- short circuit
- motor winding interrupted.
- Handle with care, to avoid damages of the compressor and its electrical components
- All materials must be properly packaged according to the type of shipment and in order to avoid damages during transport; (in case of delivery by air the compressors disassembled from a HC system, may not be allowed due to the presence of HC refrigerant diluted in the oil, or may require special measures. Consult the shipping agency before delivery).
- Do not return defective compressors as a consequence of mishandling.
- Do not return open compressors or tampered components; (to avoid erroneous diagnosis, the compressor must be opened with suitable tools, available at Embraco factories).

The material that does not correspond to the above requirements may be considered not valid for analysis and may void the warranty.

All the materials that, after analysis, appear to be working and are free of quality problems, can neither be returned nor replaced (the complete analysis involves the opening of the compressor and its disassembling).

The analyzed product, before its disposal, remains available for the customer for a maximum period of 30 days starting from the date of the Technical Report issued by the Sales and delivered to the customer.

17. TESTS ON THE CUSTOMER APPLICATIONS

Embraco "Application Test Laboratories" are available for the customers to perform tests to verify the working conditions of their equipments. For qualifying the proper use of the compressor installed, for selecting the compressor and the main components of the refrigeration system (condenser, evaporator, capillary, refrigerant charge) and other special tests that may be agreed with the customer.

The feasibility of the requested tests (and the delivery terms of the equipments) shall be agreed between the customers and Embraco Sales Department according to the Embraco Application Tests schedule.

PLEASE NOTE: THE TRANSPORT EXPENSES ARE CHARGED TO THE CUSTOMER

The test results will be given to the customer, who can use them as information or to define or modify his application.

PLEASE NOTE: THE TEST RESULTS CANNOT BE USED IN CASE OF CONTROVERSY AND ACTIONS BROUGHT AGAINST A THIRD PARTY, UNLESS THERE IS A WRITTEN AUTHORIZATION FROM EMBRACO.

APPENDIX 1 SAFETY RECOMMENDATIONS FOR COMPRESSOR INSTALLATION

GENERAL RECOMMENDATIONS



Only trained personnel can perform diagnostic and maintenance procedures on refrigeration systems.

Installation and repair requires special training, technical information, special tools and special equipment.

Make sure in advance if the environment for maintenance is adequate and airy. Tools and process equipment should be available. The required Personal Protective Equipment (PPE) must be used by the technician.

Before starting maintenance or diagnostics, first make sure that the cooling system is disconnected from the mains.

After disconnecting the system from the mains, wait for the compressor to cool down. Only perform maintenance or diagnostic procedures with the cold compressor (25 ° C ± 5 ° C).

The compressors shall be powered only in electrical installations with a ground fault circuit interrupter (GFCI) circuit breakers or residual current device (RCD), according to the country technical requirement.

Correct grounding is required for the use of compressors.



Failure to shut down the mains compressor during maintenance procedures and to apply a system without a ground fault circuit interrupter (GFCI) or residual current device (RCD), according to the country technical requirements, may cause serious physical hazards by electric shock and/or fire to the technician.



Failure to disconnect the compressor from the mains may, in the event of a short circuit in the region of the hermetic terminal of the compressor, cause expulsion of the hermetic pins causing leakage of the cooling fluid. This situation becomes more critical when applying inflammable refrigerants, because if it is associated with an ignition source, there may be flame generation and serious risks to the technician's physical integrity.

1 • ELECTRICAL ACCESSORIES

Before removing the protective plastic cover from the electrical components, check if the compressor is disconnected from the mains and that starting and / or running capacitors are used.



Never handle any electrical accessory with the compressor connected to the mains. Failure to shut down the mains compressor during maintenance procedures and to apply a system without a ground fault circuit interrupter (GFCI) or residual current device (RCD), according to the country technical requirements, may cause serious physical hazards by electric shock and/or fire to the technician.



Starting and / or running capacitors must be handled with care, as they may cause electric shock even when disconnected.

When it is necessary to remove the capacitors, carefully disconnect these components with extra attention to the exposed electrical terminals. The capacitor must be discharged before handling.

Check that the capacitance range (μF) printed on the starting and running capacitor label (if applicable) comply with the compressor data sheet that is installed in the system. The ACV Voltage value printed on the capacitor label must be equal to or greater than the value specified in the compressor data sheet. If one of the values (ACV Voltage and / or Capacitance) is not in accordance with the compressor specification, replace the capacitor.



Application of an unsuitable capacitor and / or application of unspecified starting devices (relay or PTC) may cause the capacitor to overheat. Overheated capacitors are subject to rupture which can lead to leakage of overheated material, that can lead to burns.

When necessary to disconnect the electrical components of the hermetic compressor terminal, remove the external overload protector and the starting device (relay or PTC) by applying longitudinal effort to the pins. Never apply transverse forces to the pins of the hermetic compressor terminal.



Improper removal of these accessories may cause poor electrical connection, damaging the hermetic compressor terminal, and causing refrigerant and oil leakage. This situation becomes more critical when applying flammable refrigerant, because if it is associated with an ignition source, there may be flame generation and serious risks to the technician's physical integrity.

Compare the printed code on the external overload protector, relay or PTC with the compressor data sheet. If the code is different, replace the component. There are no universal or similar electrical accessories, always use the one specified in the compressor's data sheet



Not specified starting devices (relay or PTC) may cause the capacitor to overheat. Overheated capacitors are subject to rupture which can lead to leakage of overheated material that can lead to burns.

The use of external overload protector or starting device (relay or PTC) other than specified can generate short circuit in the hermetic compressor terminal, causing the expulsion of hermetic pins causing refrigerant and oil leakage. This situation becomes more critical when applying flammable refrigerant, because if it is associated with an ignition source, there may be flame generation and serious risks to the technician's physical integrity.

1.1 • ELECTRICAL INSTALLATION

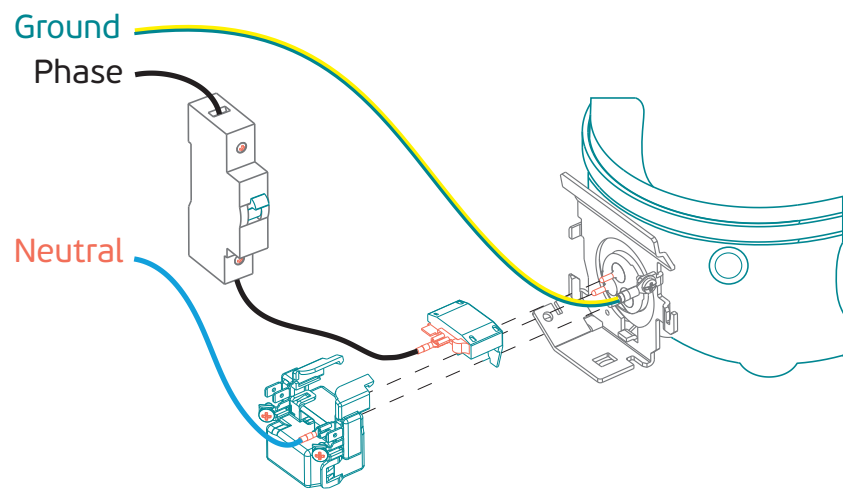

* related with products produced in Europe, illustrative picture.

In single-phase installations, the Phase wire must be protected by a circuit breaker and connected to the external overload protector. In case of internal overload protector, the Phase wire must be protected by a circuit breaker and connected directly to common pin. The neutral wire must be connected to the starting device (relay or PTC). The system must be grounded

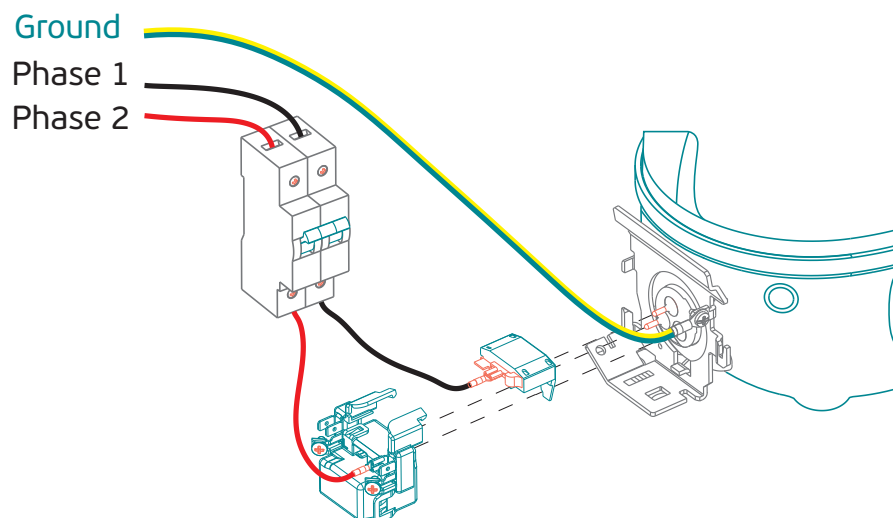

In the case of two-phase installations, it is mandatory to use a 2-pole circuit breaker, because in case of a short circuit both phases of power supply are protected. The system must be grounded



Failure to use a 2-pole circuit breaker leaves the compressor susceptible to short circuit in the region of the hermetic compressor terminal, which may cause the hermetic pins to be ejected causing the refrigerant and oil to leak. This situation becomes more critical when applying flammable gas, because if it is associated with an ignition source, there may be flame generation and serious risks to the technician's physical integrity.



Application of a system without grounding may expose the technician to risk of electric shock.

2 • COMPRESSOR

If you need to replace the compressor, be aware of the following safety recommendations:.

- I. Make sure the compressor is disconnected from the mains.



Failure to shut down the compressor from the mains during maintenance procedures may expose the technician to risk of electric shock and fire.

- II. Never remove the compressor before removing all refrigerant from the system. For this, the use of a fluid collecting machine is recommended. In the case of flammable fluids, such as R290 and R600a, ensure the removal of small accumulations of gas from the system.



The presence of flammable fluid residues may expose the technician to risk-

- III. Use a pipe cutter to disconnect the compressor tubes. Under no circumstances use the flame of the torch to disconnect the compressor tubes.



The use of a torch to disconnect compressors using flammable refrigerant may cause fire and release toxic vapors.

- IV. In case of compressor burning and / or internal contamination of the system, clean the piping with a suitable solvent applied according to the solvent manufacturer's technical guidelines.



Failure to comply with the solvent manufacturer's technical guidelines may expose the technician to fire hazards and intoxication.

- V. Before connecting a compressor, make sure that:.



- The voltage at the compressor label is suitable for the mains and the electrical installation complies with item 1.1.

The application of a compressor in incorrect voltage may cause short circuit in the hermetic compressor terminal, causing the expulsion of hermetic pins causing refrigerant and oil leakage. This situation becomes more critical when applying flammable gas, because if it is associated with an ignition source, there may be flame generation and serious risks to the technician's physical integrity.

- The plastic cover for electrical protection is properly seated.

The non-use or improper positioning of the plastic cover may expose the electrical technician the risk of electric shock and fire.



EMBRACO DIGITAL TOOLS: discover everything our digital solutions can do for you.



embraco toolboxapp

EMBRACO TOOLBOX APP

Available in all countries and in more than 10 languages, the Embraco Toolbox App has 7 functionalities which help refrigeration professionals on their daily routine. Download the App now for Android or iOS systems.



Find inside:

- CROSS-REFERENCE
- PRODUCT CATALOGUE
- DISTRIBUTOR LOCATOR
- UNIT CONVERTER
- REFRIGERANT SLIDER
- REFRIGERATION CLUB
- TROUBLESHOOTING



REFRIGERATION CLUB

Exclusive content for refrigeration professionals in a global channel. Keep updated and join us at: www.refrigerationclub.com



PRODUCT SELECTOR SOFTWARE

Choose the best solution for your cooling system at Embraco's official portfolio platform. Access: products.embraco.com





www.embraco.com